

**TURCK**

Industrial  
Automation

**BL ident® –  
MODULAR  
RFID SYSTEM**

**UHF**

**HF**

***Sense it! Connect it! Bus it! Solve it!***



# BL ident® modular RFID system – HF/UHF

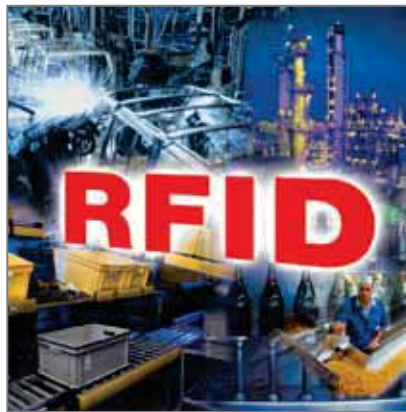

# The company



## The company

TURCK is one of the leading manufacturers in industrial automation. With more than 3.200 employees in 27 countries as well as sales partners in further 60 states, we are always close to you. As a specialist in sensor, fieldbus, connection and interface technology and also human-machine interfaces (HMI) and RFID, we offer

efficient solutions for factory and process automation. With our state-of-the-art production facilities in Germany, Switzerland, the USA, Mexico and China we, as a family-owned company, are able to react quickly and flexibly to the demands of local markets.



## The product portfolio

Whether for machine & system engineering, the automotive sector, transport & handling, food & beverage or for chemical and pharmaceutical industries. But this is not all! Our efficiently standardized products help you to cut down on costs for purchase, storage, installation and operational safety. You get the best solu-

tions for your automation lines. This is possible thanks to the industry-specific knowledge we have acquired in close cooperation with our customers and through continuous further development of electronics and production on the highest level.



### Our service

With nearly 50 years of experience and extensive know-how, we support you in each phase of the project, from a first analysis up to tailor-made solutions and commissioning of your application. We aim at enhancing the efficiency and productivity of your production processes

and machines continuously. With the excellent quality of our products, the support of our specialists and our fast delivery service, your systems will always run to the highest possible capacity.



### The product data base

Whether software tools for programming, configuration or commissioning support, our data sheets or CAD data are available in 80 export formats. Our website [www.turck.com](http://www.turck.com) helps you to find products and solutions fast, seven days a

week, at any place worldwide and in nine different languages. You have access to nearly all products and solutions – clearly structured, completely documented and free for download.

# Table of contents

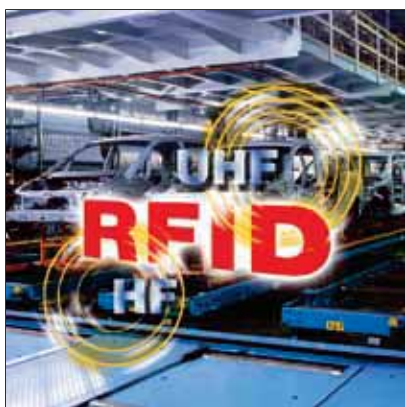

## **BL ident® modular RFID system – HF/UHF**

Both technologies, proven interference immune HF and long range UHF are combined in one identification solution, in *BL ident®* the modular RFID system. Even in harsh industrial environments and with data exchange on-the-fly you achieve noticeably longer ranges. *BL ident®*, the all-in-one system, offers data carriers, read/write heads, connection technology and interfaces (com-

plete sets with gateway and pluggable RFID modules), that can be combined in any way required. The I/O systems BL67 (field application), BL20 (cabinet mounting) and *BL compact* (field application) are the basic components of the modular concept. Fieldbus interfaces for PROFIBUS-DP, DeviceNet™, EtherNet/IP, EtherCAT® , PROFINET IO and Modbus TCP are available.



## **How do I find the right solution for my application?**

The **Overview** in chapter one informs about construction, system integration and application areas of the *BL ident®* system. Information on the combination possibilities of *BL ident®* modules can be obtained from the chapters „Read/write heads and data carriers“. **Type codes** and **Tables** include details about the device types and technical features and are to be found in all chapters. Should you

already know the type code or the ID number of a sensor, please refer to the **Type index** on page 124. It guides you to the desired product. You find a **QR-Code** on the first page of each chapter. It will guide you directly to our online product database with detailed information on the product groups of your choice.

	<b>BL ident® modular RFID system – HF/UHF</b>	Page 7	BL ident® modular RFID system – HF/UHF
	Short description, system structure, system integration, HF and UHF – Advantages, Applications		
	<b>Interfaces (Sets) – HF and UHF</b>	Page 23	Interfaces (Sets) – HF and UHF
	Overview/Type code	Page 24	
	Modular system in IP67	Page 28	
	Modular system in IP20	Page 33	
	Compact interfaces – <i>BL compact</i>	Page 40	
	<b>Connectivity solutions – HF and UHF</b>	Page 43	Connectivity solutions – HF and UHF
	Type code	Page 44	
	BL ident® extension cables for interface and read/write head – HF/UHF	Page 46	
	<b>Accessories – HF and UHF</b>	Page 53	Accessories – HF and UHF
	Mounting accessories	Page 54	
	Mobile handhelds	Page 64	
	<b>Read/write heads and data carriers – HF</b>	Page 67	Read/write heads and data carriers – HF
	Type code	Page 68	
	Read/write heads – HF	Page 70	
	Data carriers – HF	Page 78	
	Overview: Combination possibilities and ranges	Page 86	
	<b>Read/write heads and data carriers – UHF</b>	Page 91	Read/write heads and data carriers – UHF
	Type code	Page 92	
	Read/write heads – UHF	Page 94	
	Data carriers – UHF	Page 96	
	<b>General information</b>	Page 102	General information
	Materials	Page 102	
	Explosion protection	Page 104	
	Glossary	Page 116	
	<b>Wiring diagrams</b>	Page 122	Wiring diagrams
	<b>Index of types</b>	Page 124	Index of types





# BL ident® modular RFID solution



Scan the QR code  
to access our prod-  
ucts on the internet

## BL ident® modular RFID system – HF/UHF

BL ident® is an all-in-one RFID system designed for industrial applications. The I/O systems BL67 (field application), BL20 (cabinet mounting) and BL compact (field application) are the basic components of the modular concept.

Whether deployed in production control, logistics or automation processes: You can use both technologies, interference immune HF (13.56 MHz, ISO 15693) and long range UHF (865...928 MHz country-specific, ISO 18000-6C/EPCglobal Class 1 Gen 2) in one identification solution, in BL ident® the modular RFID system from TURCK. No matter if applied in harsh industrial environments or data exchange on-the-fly, you achieve considerably longer ranges.

Data carriers, read/write heads, connection technology and interfaces (gateway

and RFID electronic modules) can be combined to a customized BL ident® solution. You can choose from extremely fast and almost infinitely writable FRAM data carriers, but also from high-temperature versions for paint-spray lines that resist up to +240 °C. BL ident® can be integrated in existing system configurations via gateways which are available for all standard fieldbus protocols.

The system has a very long service life because it operates wear-free and contactless. It is insensitive to temperature fluctuations, dirt, water and oils. BL ident® is a future-proof investment and interoperable, thanks to the open and worldwide applied standards BL ident® – Use the advantages of HF and UHF combined in one RFID solution!

# Our strengths



## HF and UHF – Parallel operation

You can use both technologies, interference immune HF (13.56 MHz, ISO15693) and long range UHF (865...928 MHz, ISO 18000-6C/EPCglobal Class 1 Gen 2) in one identification solution, in *BL ident*® the modular RFID system from TURCK. Even in harsh industrial environments and with data exchange on-the-fly you

can control your systems seamlessly across greater distances with RFID. HF and UHF read/write heads can be connected and operated at the same interface. No matter what technology you use, one function block provides identical control functionality for both types.



## Modular system

Each *BL ident*® system can be customized to fit in your application and it can also be extended at a later stage if required. Up to 16 read/write heads can thus be connected to a bus node. Additional sensors and actuators can be connected by simply adding further I/O modules. The product range features IP69K rated components for very demanding applications with many different data carriers

and read/write heads as well as extendible IP20/IP67 interfaces (gateways and RFID modules) that are easily connected to the control environment and for which many matching extension cables are available. *BL ident*® is thus quickly and flexibly integrated in existing topologies even under demanding application conditions.



## Long ranges with highspeed data transmission

Read/write ranges of up to one meter in the HF range and several meters in the UHF range are possible. The *BL ident*® data carriers with FRAM memory guarantee fast 0.5 ms/byte transmission. The data carriers can be read and written on

the fly – the FRAM data carriers up to  $10^{10}$  times. TURCK *BL ident*® interface sets with CODESYS programmable gateways (acc. to IEC 61131-3) transmit the process relevant data quickly to the control system.



### For all application areas

*BL ident*® has the right data carrier for every application – extremely small ones (Ø 7.5 mm), devices with FRAM memory for max. 8 kbyte highspeed reading and many writing cycles, thermostable data carriers for max. 240 °C and data carriers

for direct mounting on metal or in Ex-areas. Customized solutions are also possible, thanks to the open and worldwide applied standards (ISO 15693 and ISO 18000-6C)



### Flexibly connected to the system

*BL ident*® interfaces (gateway and RFID modules) in IP20 and IP67 connect the RFID system to the control system. All standard protocols are possible, PROFIBUS-DP, EtherNet/IP™, Modbus TCP, DeviceNet™, PROFINET IO, CANopen und EtherCAT®. For complex applications use the programmable gateways. They are the right choice for peripheral and inde-

pendent control tasks. For simple I/O communication use the RFID modules from our portfolio. They are quickly integrated just like I/O modules without any control and programming effort involved. In combination with ready-made *BL ident*® extension cables you get more flexibility when connecting the read/write heads.



### Application-optimized components

No matter what requirements the application may impose, *BL ident*® proves its strengths especially in demanding environments. For example, the thermostable HF and UHF data carriers resist temperatures of up to 240 °C and can be used in paint-spray lines or autoclaves. Or read/write heads made for roller conveyors in intralogistics or for highspeed

applications. Read/write heads and data carriers that are resistant to all common acid and alkaline cleaning agents are especially suited for Food & Beverage applications. ATEX approved components are available for process automation systems. *BL ident*® even offers the right solution for components that must be mounted on metal.

# Your advantages

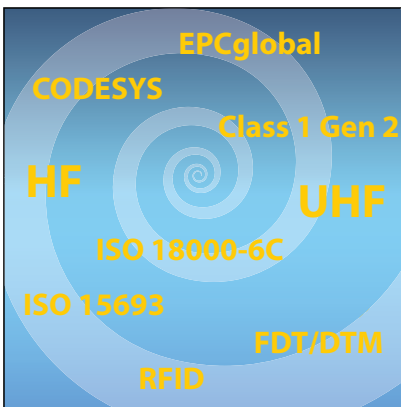

## Future-proof investment

BL ident® can be adapted flexibly to new system demands. Additionally required read/write units are simply added by connecting further RFID modules to the available interface. Changing the fieldbus is no problem either. BL ident® is easily migrated to other fieldbuses by merely exchanging the gateway. Modules and read/write units can be used with all

fieldbuses. Even changing the frequency band is easy with BL ident®. UHF and HF read/write heads can be connected to the same gateway and operated in parallel. International standards (ISO 15693/ISO 18000-6C) ensure global interoperability of the system and secures your future investments.

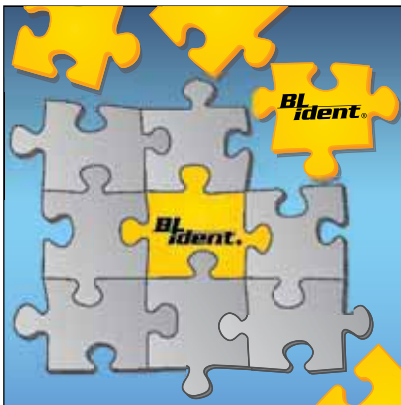

## Maximum flexibility

Whatever the tasks are, with BL ident® you solve even complex jobs. The modular principle allows you to implement perfectly tailored RFID solutions without any compromise. Our product portfolio offers the right modules for any application. You can choose from data carriers (also called tags) in all shapes and sizes, for high-temperature applications or au-

toclaves as well as types for the food industry and the Ex-area. Moreover, we offer an extensive selection of read/write heads, rugged, rectangular and cylindrical types, as well as interfaces for all standard fieldbus systems. Use our tailor-made connection and fieldbus technology and our HMI solutions to integrate your RFID solution easily in your system.

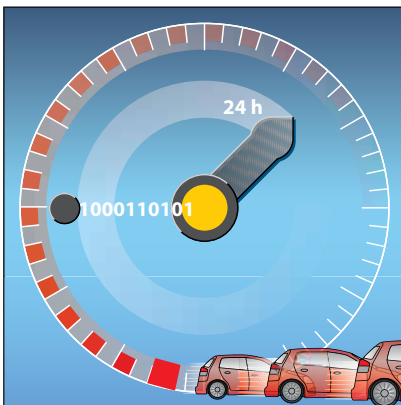

## Efficient production

With BL ident® you can adapt your production and assembly processes flexibly and fast to new demands. The RFID system from TURCK guarantees short changeover times to keep up with the required cycle times. In addition, RFID data carriers improve the transparency of production processes: Through maintenance reports written to the data carriers, preventive maintenance can be re-

financed and parts can be replaced before they fail and provoke a system breakdown. All production relevant data is stored on the BL ident® data carriers, attached directly at the object. Different production locations can thus be linked. The supply chain management becomes transparent from production to logistics, thanks to the rugged and rewritable data carriers.

# Advantages

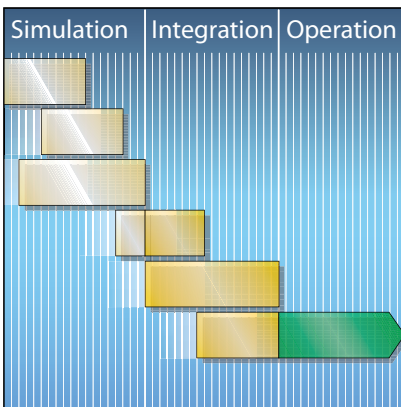

## Fast implementation of projects

BL ident® enables you to implement projects fast thanks to highest possible modularity and flexibility. The air interfaces of different system setups can be simulated under customized conditions, before installing the hardware. For HF applications use the RFID simulator and for UHF use Ray-Tracer. You can check

your RFID solution according to involved costs and efforts already in the planning stage and thus implement your project much faster. The advantage: Less time for piloting fosters quick return on investment (ROI) and this is essential for business success.



## High availability

The rugged and modular BL ident® concept extends the service intervals and increases the availability of your system. If you wish to extend your system, you can plug and remove the electronic modules and the read/write heads in ongoing operation. Thanks to the rugged design, up

to 8 kbyte of product-related data can be written to the data carriers during the production process and stored for up to 10 years. The gathered information helps you to assess possible interferences instantly and to improve the availability of your systems.

	2498-005	EPC 2498
		01 120524 10:34 in
		body construction
		02 120524 10:55 ok
		03 120524 11:15 ok
		04 120524 11:37 ok
		05 120524 12:05 ok
		06 120524 12:43 ok
		07 120524 13:22 ok
		08 120524 13:53 ok
		paint-spray line
		09 120524 14:15 ok
		10 120524 14:44 ok
		11 120524 15:02 ok
		12 120524 15:33 ok
		13 120524 15:57 ok
		14 120524 16:44 ok
	15 120524 17:23 ok	
	assembly	
	16 120524 17:53 ok	
	17 120524 18:32 ok	

## Automatic data collection and highest possible transparency

Whether used in industrial production, logistics or QA processes, with BL ident® from TURCK you cover the entire production process from start to end. All information is centrally available - no matter how rough the application environments are. The data carriers are mounted on products or containers where they identify intermediate and end production stages. The read/write heads can be

mounted in many different ways. They read data before or after relevant production processes or at the end of the production chain. This provides more transparency and gives you the possibility to operate your plant highly efficient and to use the gathered data in many ways. The end product is delivered together with a QM protocol containing all the production steps.

# System – Modular and flexible structure

## BL ident® interfaces

- Up to 16 channels per interface
- Cabinet installation (BL20)
- Field installation (BL67)
- Fieldbus connection for PROFIBUS-DP, DeviceNet™, CANopen, PROFINET IO, Modbus TCP, EtherNet/IP™, EtherCAT® CODESYS programmable gateways
- Additional compact fieldbus connections with RFID and I/Os for installation in the field (*BL compact*)
- Interfaces for Ex applications (BL20)

## BL ident® read/write heads

- Fully encapsulated, rugged HF read/write heads, rectangular and cylindrical design
- UHF read/write heads designed for industrial use
- Read/write heads for the Ex-area (ATEX) and Food industry applications (Wash-Down, IP69K)
- HF (13.56 MHz) and UHF (865 to 928 MHz) devices
- Read/write ranges, 1 meter (HF) or several meters (UHF), depending on environment

## BL ident® data carriers

- EEPROM data carriers with 128 byte memory, FRAM data carriers of up to 8 kbyte for high speeds and nearly unlimited write cycles
- High-temperature data carriers -40...+240 °C, depending on environment
- Data carriers for autoclaves, resist high-pressure steam jet cleaning at +121 °C
- Data carriers for direct mounting on metal
- Open, worldwide valid standards (ISO 15693 und ISO 18000-6C)
- Data carriers for use in Ex-areas

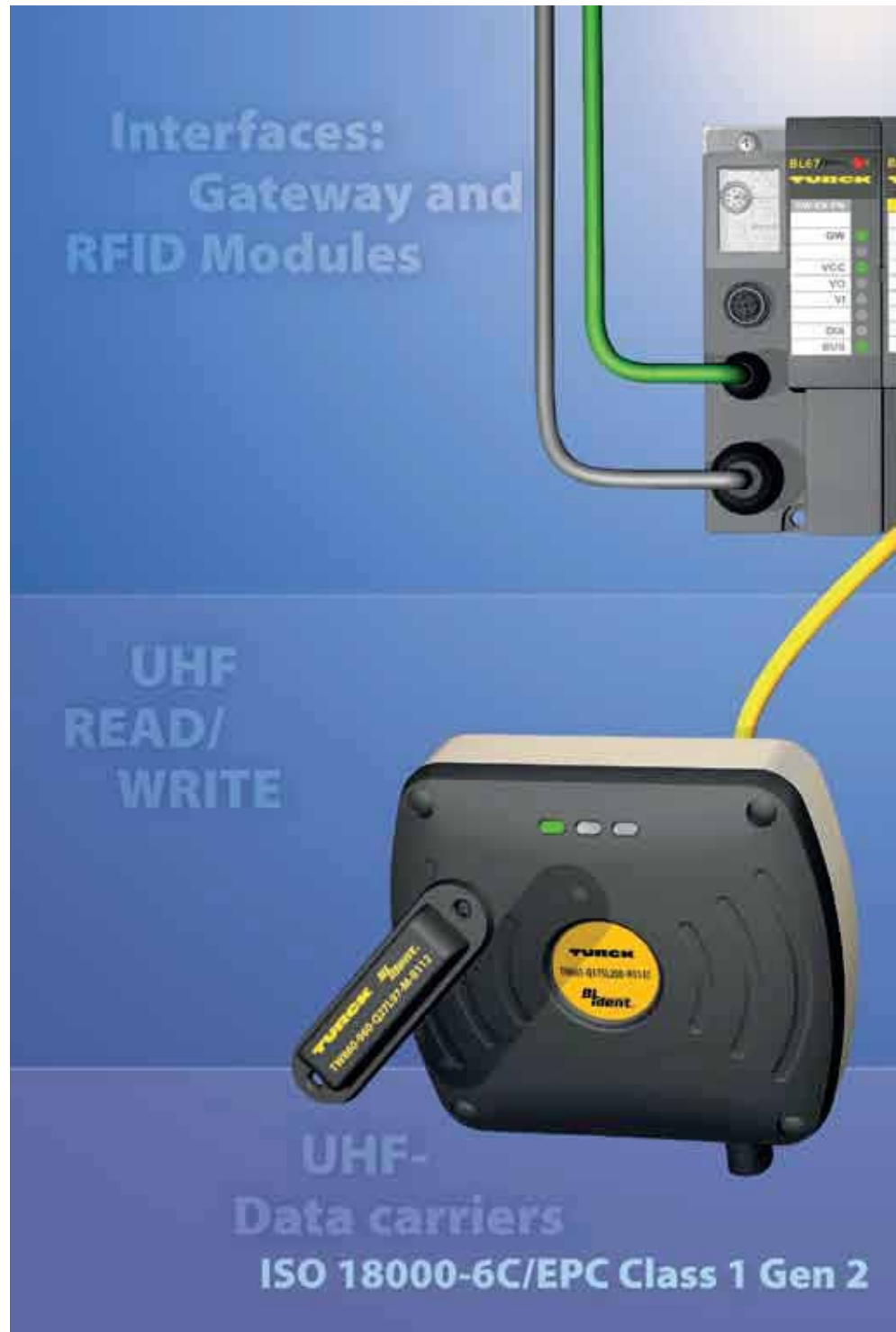

# ure and flexible



## BL ident® connectivity

- Ready-made fieldbus and power cables
- Connection accessories for bus and power supply
- Ready-made cables for connection of interface and read/write head
- Connection and extension cables for food applications
- Max. cable length to read/write head 50 m

## BL ident® accessories

- Extensive range of accessories for exact fitting and easy mounting of read/write heads and data carriers
- Closure caps and housings provide extra protection against welding sparks
- Mobile HF and UHF handhelds for reading and writing of mobile data carriers; available with touch screen, Bluetooth, WLAN, barcode scanner and application software

# System integration – Quick and easy



### For all standard control systems

BL ident® is easily and flexibly connected to the control system via gateways. All standard industrial protocols are available, such as PROFIBUS-DP, DeviceNet™, EtherNet/IP, EtherCAT®, PROFINET IO and Modbus TCP. Connection to the fieldbus is established via BL ident® interfaces. They are obtainable as a set together with the gateway and one to four RFID

modules. 2, 4, 6, 8 or 16 channels are possible per interface. More interface sets can subsequently be added. We offer RFID-S modules for simple I/O communication and RFID-A modules for more complex applications with function blocks (PIB). Our product portfolio also comprises the compact IP67 interfaces of the BL compact series for small spaces.

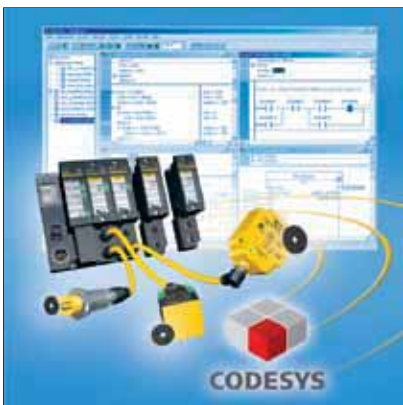

### Peripheral RFID communication

BL20 and BL67 interfaces as well as CODESYS programmable gateways relieve the higher level control system. The gateways are easy to program and fulfill local control and diagnostic tasks. The local intelligence is very important for the

handling of data and easy integration in the control environment. The Proxi Ident Block (PIB) which is needed for control tasks is operated via the programmable gateway.



### Easy I/O communication

Simple I/O communication needing no function blocks can be implemented with BL ident® solutions based on the 8-byte I/O modules BL20-2RFID-S and BL67-2RFID-S (S = simple RFID Interface).

They reduce the programming effort considerably and allow you to connect BL ident® to all standard control systems without function block.



# – Quick and easy



### BL ident® – HF-RFID simulator

General information on RFID components are simply not enough to choose the right components for your application. It is rather the complex interaction between read/write head and data carriers that delivers useful parameters such as data volume, speed and read-write distance. The *BL ident®* simulator helps you to simulate your application and to

pre-select the required RFID-HF components. It allows you to „play“ with values and to find out the possibilities and limits of different combinations. The simulator also generates the required technical documentation such as technical data sheets. The online version of the simulator is free for download on [www.turck.com](http://www.turck.com).

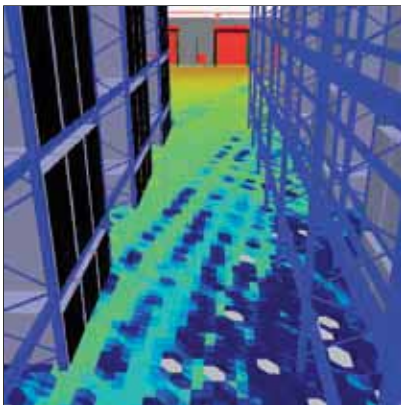

### BL ident® – UHF-RFID Ray-Tracer

The Ray-Tracer software allows you to simulate different UHF-RFID system constellations under real conditions. You can narrow down the choice of suitable components prior to installation of the UHF-RFID hardware. The Ray-Tracer also analysis the technical feasibility of UHF-RFID solutions under given complex applica-

tion conditions. The results provided, help to evaluate the expected costs and efforts for planning and analysis of UHF-RFID systems. Please don't hesitate to contact us. We will implement the simulation for your UHF application.



### Efficient parametrization

*BL ident®* is parametrized via the graphical user interface of the FDT/DTM based application *PACTware®*. Read and write commands as well as diagnostic functions are easily implemented without control system. This makes testing and commissioning on site easy. UHF read/

write heads can be tested, parametrized and configured thoroughly according to the required demands with the software tools „RDemo“ and „WebConfig“. Read/write properties can be optimized even under difficult application conditions.

# TURCK system solutions



## BL20/BL67 – Remote-I/O systems in IP20/IP67

BL ident® can be extended with standard I/O modules in IP20/IP67. The Remote I/O systems BL20 for cabinet installation and BL67 for field installation offer flexibility and planning freedom on all levels: The modules are operated via the gateway and thus independently from the

fieldbus. Thanks to the modular concept, the system can be customized to plant-specific analog and digital signal processing. BL67 electronic modules can be hot-swapped without having to disconnect the field wiring.



## BL compact modules in IP67

BL compact combines the signal variety of BL67 systems with the simple design of the block IOs. The outcome is a compact IP67 module, custom-made, space-saving and easy to service. The BL compact portfolio comprises tailor-made interfaces for the BL ident® RFID system. They are equipped with standard metal round connectors and the

electronics is potted and incorporated in a fiber-glass reinforced plastic housing. LEDs indicate local diagnostics and status. The modules are available as 2 or 4-channel RFID blocks or as a combination of 2 RFID channels with digital I/O channels for example, for trigger signals or for point-to-bus control.



## VT250 – HMI operator panels

The HMIs (Human Machine Interfaces) of the VT250 series are equipped with a 5.7"-TFT color touch screen that can be used as an operating or control panel. The VT250 hardware supports all relevant fieldbus and RT-Ethernet protocols. The controller integrated in the VT250 is configured with CODESYS 3, the IEC 61131 compliant programming software. PLCs and all supported fieldbuses can also be configured with this soft-

ware, thanks to OOP-programming (object-oriented programming). QVIS, is the visualization software which was especially developed for embedded systems. QVIS and CODESYS are closely linked and responsible for the import of icons and exchange of data. QVIS also provides drivers for different control systems to implement different visualization solutions.

tions



### Connection technology

Ready-made cables in different lengths for secure transmission of data in harsh industrial environments. Whether shielded, with PUR sheath or PVC, silicone and halogen-free, highly flexible, irradiated, highly stable or resistant to weld splatter and oils: TURCK offers the matching connectivity for your application. With a cable length of maximally 50 m between

interface and read/write head, flexible integration in your system is guaranteed. This helps you to reduce the number of bus notes and bus addresses. Extension cables especially made for the food industry, withstand cyclic cleaning processes and thus guarantee failsafe operation of your machines.

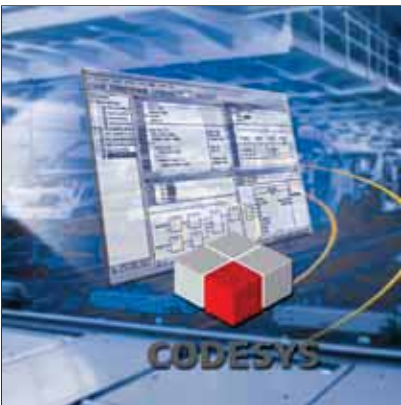

### Programming software CODESYS

Gateways are programmed with CODESYS to become peripheral control units. The GUI supports all IEC-61131-3 programming languages

- Instruction List (IL)
- Ladder Diagram (LAD)
- Function Block Diagram (FBD)

- Structured Text (ST)
- Sequential Function Chart (SFC)

Numerous available diagnostic and commissioning tools as well as preassembled function blocks for the RFID system *BL ident*® make BL20 and BL67 extremely versatile.



### Easily parametrized via FDT/DTM

The FDT frame application *PACTware*™ (Process Automation Configuration Tool) supports you in planning and implementing your RFID application independently from the fieldbus used. Whether in online or offline mode, for system startup or for testing, with *PACTware*™ you can easily configure and parametrize

modules. Different devices and DTMs (Device Type Manager programs) for communication are available. They are set up and integrated via the GUI (standard Graphical user interface). The DTMs can be integrated in any FDT frame application. DTMs and *PACTware*™ are available as freeware on [www.turck.com](http://www.turck.com).

# HF and UHF – Advantages in a double



## Integrative RFID identification in production, logistics and distribution

HF 13.56 MHz and UHF 840...960 MHz frequencies have become standard in industrial use for read/write heads and passive data carriers. Both technologies HF and UHF operate at long ranges, transmit data rates at high speed and are very rugged and best suited for the in-

tended processes and purposes. With the TURCK RFID system *BL ident*® both technologies can be operated in parallel for entire control of the supply chain, from production, over distribution up to logistics.



## No additional effort for mounting and commissioning

Extensive configuration is not required. Just connect HF or UHF read/write heads to the same *BL ident*® interface. Mixed operation of HF and UHF is also possible. Cable lengths of up to 50 m between interface and read/write head, provide many installation options. Unlike passive

antennas with external electronics which require high-frequency cables, TURCK read/write heads have the antenna and the electronics incorporated in the same housing and thus transmit data without problems even when exposed to electromagnetic interference.



## Long range operation even in harsh industrial environments

UHF RFID systems transmitting within 865...928 MHz are preferably used for long range and fast data transmission between read/write head and data carrier. *BL ident*® achieves ranges of several meters, depending on the combination of read/write head and data carrier used. You will not only gain more operational

reliability in automated processes but also achieve highest possible flexibility in manually operated identification systems. The data carriers are entirely maintenance-free, thanks to power supplied passively via the read/write head's electromagnetic field.

# Advantages in a double pack



### Bulk reading – simultaneously, fast, securely

BL ident® can exchange data simultaneously with many data carriers – in HF as well as in UHF mode. Bulk reading on-the-fly is also possible. The UHF technol-

ogy is thus especially suited for applications in which objects have to be captured very fast.



### Optimization potential on the basis of approved industrial standards

Both technologies HF (13.56 MHz, ISO 15693) and long range UHF (840...960 MHz country-specific, ISO 18000-6C/EPCglobal Class 1 Gen 2) have become RFID standard especially in industrial environments. Thanks to inter-

national standards and global applicability, read/write heads and data carriers can be combined in many different ways, thus providing highest investment security – even across borders and continents.

# Applications – Many solutions



## Integrative identification of all components in car assembly processes

RFID solutions are in use for two decades already, especially in the automotive industry where they are deployed for tracking car bodies conveyed by automated transport systems. Owing to TURCK's RFID expertise, end-to-end identification in automotive production is now possible. Not only the transport systems can be equipped with RFID data carriers but also every car body and single component. The automotive industry

thus profits from integrative identification and quality assurance. Through the entire production process, including also the paint-spray lines where data carriers are exposed to temperatures of around 200 °C, they remain firmly attached to the body. The long range *BL ident*® UHF technology enables fast and reliable transfer of product data over several meters, between data carrier and read/write head.



## RFID solutions for the food industry

*BL ident*® provides a complete solution package for the special requirements of the food and feed industry: Besides special data carriers for autoclaves that withstand high-pressure steams at +140 °C, the product portfolio also comprises read/write heads for Wash-Down applications, Food & Beverage extension cables, as well as fieldbus and interface components for cabinet (BL20) and field (BL67) installation. *BL ident*® RFID systems

can be deployed in autoclaves and also in Track & Trace applications from end to end. The fully automated exchange of data between data carriers, read/write head and higher level control system, makes the entire supply chain secure and always traceable. The end product is delivered together with a QM protocol containing all the production steps.



## Secure identification of tumbler screens in the dust Ex-zone 22

The chemical group WACKER produces among other products dispersible polymer powders in different granulation for different designated purposes. To ensure correct sieving, the mesh width of the tumbler screens should be monitored automatically by an RFID system. The choice fell on *BL ident*® because it is ap-

proved for dust Ex-zone 22. Four tumbler screens are equipped with Ex-zone 2 and 22 approved TNL-R-Q80 read/write heads for all screens with TW-R50-Ex data carriers. In addition, TURCK has also customized the accompanying function block to the existing Siemens PLC S7.

# Industry solutions



## Just in time delivery of pressed parts.

The US-American company Tower Automotive maintains a production site in Gent (Belgium) where daily around 700 pressed parts are produced and send directly to Volvo. In order to guarantee just-in-time delivery, Tower Automotive has to ensure a reliable production flow. Transparent production or rather „Tracking & tracing“ is thereby very important.

To fulfill this task, the planners at Tower Automotive decided for the TURCK RFID technology. *BL ident*® withstands high temperatures of +180 °C in curing ovens and reads and writes on the fly. Thanks to this advantage, Tower Automotive was able to reduce the read/write time by two seconds per station and was thus able to speed up the production process.

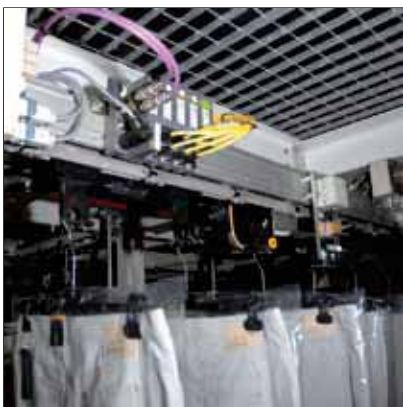

## Smooth flow of goods in the logistics center

The clothing manufacturer Leineweber maintains a logistic center in Herford near Bielefeld where hanger goods like trousers from the trade mark BRAX are sorted. *BL ident*® the RFID system from TURCK guarantees that up to 750.000 single pieces can be processed by the fully automated system, thus ensuring that the trousers reach their destination. The technicians have installed 28 read/write heads which are connected to

the control system via seven I/O stations with PROFIBUS connectivity. 1.700 data carriers are installed in the skirts where they identify every single piece of clothing. The distance between the data carriers is 250 mm. At a transport speed of 34 meters per minute and a daily production cycle of 16 hours, the RFID system reads data carrier IDs 130,560 times a day.



## Long-range UHF technology in logistics

Thanks to the long-range UHF technology, many more industries can now profit from the advantages of *BL ident*®, and in particular from the additional saving potential it provides. The UHF data carriers are not only applied in industrial core processes such as production lines, but also in upstream and downstream processes such as the intralogistics. A well-known North European supermarket

chain has equipped its logistics center entirely with the TURCK UHF technology. As many as 300 RIFD read stations identify pallet types and goods on the fly. The TURCK solution convinced with its high-speed reading rates, fast bulk reading of several data carriers as well as flexible data linking and programmability of the handhelds.





# Interfaces – HF and UHF



Scan the QR code to access our products on the internet

## BL ident® interfaces (sets) fieldbus connection – HF/UHF

BL ident® interfaces are obtainable as a set together with the gateway and one to four RFID modules in IP20 or IP67. The interfaces provide the connectivity to PROFIBUS-DP, EtherNet/IP™, Modbus TCP, DeviceNet™, PROFINET IO, CANopen und EtherCAT®. You can subsequently connect RFID modules to the interface. Maximally 16 channels can be operated in parallel. In addition to fieldbus-specific diagnostic messages, also fieldbus status and power supply of the individual channels is signalled via LEDs. Programmable gateways enable distributed and fast signal processing. Our product portfolio also comprises standard function modules for easy integra-

tion in the control and fieldbus network. Even simple I/O communication needing no function blocks, can be implemented with BL ident® solutions based on the 8-byte I/O modules BL20-2RFID-S and BL67-2RFID-S (S = simple RFID Interface). They reduce the programming effort considerably and allow you to connect BL ident® to all standard control systems without function block.

BL compact offers tailor-made, compact, fully potted and IP67 rated interfaces as an alternative to the BL20 and BL67 interface sets. They are the perfect solution for applications demanding a space-saving arrangement of components.

# Modular interfaces (sets) – BL20/BL67

## BL ident® interface set: Gateway + Electronic modules (each with a base module) – Protection class IP20

Fieldbus	Interface set: Type x = Number of channels	Gateway Type <sup>1</sup>	Gateway, programmable	Electronic modules Type BL20-2RFID-A: Function block PIB <sup>2</sup>	Typ BL20-2RFID-S: 8-byte I/O communication
PROFIBUS-DP	TI-BL20-DPV1-x	BL20-GW-DPV1		x <sup>3</sup>	
	TI-BL20-DPV1-S-x	BL20-GW-DPV1			x
	TI-BL20-E-DPV1-x	BL20-E-GW-DP		x <sup>3</sup>	
	TI-BL20-E-DPV1-S-x	BL20-E-GW-DP			x
DeviceNet™	TI-BL20-DN-S-x	BL20-GWBR-DNET			x
	TI-BL20-E-DN-S-x	BL20-E-GW-DN			x
CANopen	TI-BL20-E-CO-S-x	BL20-E-GW-CO			x
Modbus TCP	TI-BL20-EN-S-x	BL20-GW-EN			x
	TI-BL20-PG-EN-x	BL20-PG-EN	x	x	
	TI-BL20-PG-EN-S-x	BL20-PG-EN	x		x
EtherNet/IP™	TI-BL20-EIP-S-x	BL20-GW-EN-IP			x
	TI-BL20-PG-EIP-x	BL20-PG-EN-IP	x	x	
	TI-BL20-PG-EIP-S-x	BL20-PG-EN-IP	x		x
PROFINET IO	TI-BL20-E-PN-x	BL20-E-GW-PN		x <sup>3</sup>	
	TI-BL20-E-PN-S-x	BL20-E-GW-PN			x
EtherCAT®	TI-BL20-E-EC-S-x	BL20-E-GW-EC			x

## BL ident® interface set: Gateway + Electronic modules (each with a base module) – Protection class IP67

Fieldbus	Interface set: Type x = Number of channels	Gateway Type <sup>1</sup>	Gateway, programmable	Electronic modules Typ BL67-2RFID-A: Function block PIB <sup>2</sup>	Typ BL67-2RFID-S: 8-byte I/O communication
PROFIBUS-DP	TI-BL67-DPV1-x	BL67-GW-DPV1		x <sup>3</sup>	
	TI-BL67-DPV1-S-x	BL67-GW-DPV1			x
	TI-BL67-PG-DP-x	BL67-PG-DP	x	x	
	TI-BL67-PG-DP-S-x	BL67-PG-DP	x		x
DeviceNet™	TI-BL67-DN-S-x	BL67-GW-DN			x
Multiprotocol: Modbus TCP + EtherNet/IP™	TI-BL67-EN-S-x	BL67-GW-EN			x
Modbus TCP	TI-BL67-PG-EN-x	BL67-PG-EN	x	x	
	TI-BL67-PG-EN-S-x	BL67-PG-EN	x		x
EtherNet/IP™	TI-BL67-PG-EIP-x	BL67-PG-EN-IP	x	x	
	TI-BL67-PG-EIP-S-x	BL67-PG-EN-IP	x		x
PROFINET IO	TI-BL67-EN-PN-x	BL67-GW-EN-PN		x <sup>3</sup>	
PROFINET IO + AIDA connection technology	TI-BL67-PN-AC-x	BL67-GW-EN-AC		x	
	TI-BL67-PN-AC-S-x	BL67-GW-EN-AC			x

<sup>1</sup> Refer to the corresponding type codes for more information

<sup>2</sup> Extended RFID communication with PIB function block

<sup>3</sup> Extended RFID communication with PIB function block via Siemens S7 control

# (sets) – BL20/BL67

## Type code – example

**T** **I** - **BL67** - **PG** - **DP** - **S** - **2**

## Type code – explanation

<b>T</b>	<b>I</b>	Interface set	-	<b>BL67</b>	Modular I/O system	-	<b>PG</b>	Programmable gateway	-
		<b>Device Type</b> <b>I</b> Interface set: gateway and RFID modules  TURCK RFID system <i>BL ident</i> ®			<b>Modular I/O system</b> <b>BL20</b> cabinet mounting (IP20) <b>BL20-E</b> cabinet mounting (IP20) ECONOMY version <b>BL67</b> field application (IP67)			<b>Programmable gateway</b> <b>PG</b> Programmable gateway	

<b>DP</b>	<b>S</b>	Fieldbus	-	<b>S</b>	Communication	-	<b>2</b>	Number of channels
		<b>Fieldbus</b> <b>DP/DPV1</b> PROFIBUS-DP <b>EN-PN</b> PROFINET IO <b>EN</b> Modbus TCP <b>EIP</b> EtherNet/IP™ <b>EC</b> EtherCAT® <b>DN</b> DeviceNet™ <b>CO</b> CANopen			<b>Communication</b> <b>A</b> data transfer via function block (PIB) in the control unit or programmable Gateway <b>S</b> data transfer via I/O communication			<b>Number of channels</b> <b>2</b> 2 channels for 2 read/write heads <b>4</b> 4 channels for 4 read/write heads <b>6</b> 6 channels for 6 read/write heads <b>8</b> 8 channels for 8 read/write heads

# Compact interfaces – BL compact

## BL compact interfaces in IP67 – Possible combinations and functions

Fieldbus	BL ident® interface – Type <sup>1</sup> (Gateway + I/O communication)	Function	Type ...2RFID-A: PIB function block	Type ...2RFID-S: 8-byte I/O- communication
PROFIBUS-DP	BLCDP-2M12MT-2RFID-A BLCDP-2M12MT-2RFID-S	2 x read/write heads	x <sup>2</sup>	x
	BLCDP-6M12LT-2RFID-A-8DI-PD BLCDP-6M12LT-2RFID-S-8DI-PD	2 x read/write heads + 8 x digital inputs	x <sup>2</sup>	x
	BLCDP-6M12LT-2RFID-A-8XSG-PD BLCDP-6M12LT-2RFID-S-8XSG-PD	2 x read/write heads + 8 x digital inputs/outputs (configurable)	x <sup>2</sup>	x
DeviceNet™	BLCDN-2M12S-2RFID-S	2 x read/write heads		x
	BLCDN-4M12L-2RFID-S-2RFID-S	4 x read/write heads		x
	BLCDN-6M12LT-2RFID-S-8XSG-PD	2 x read/write heads + 8 x digital inputs/outputs (configurable)		x
CANopen	BLCCO-2M12S-2RFID-S	2 x read/write heads		x
	BLCCO-6M12T-2RFID-S-8XSG-P	2 x read/write heads + 8 x digital inputs/outputs (configurable)		x
Multiprotocol: Modbus TCP + EtherNet/IP™	BLCEN-2M12LT-2RFID-S	2 x read/write heads		x

<sup>1</sup> Refer to the corresponding type codes for more information

<sup>2</sup> Extended RFID communication with PIB function block via Siemens S7 control

# – BL compact interfaces –

## Type code – example

**BLCDP** – **2** **M12** **S** **T** – **2RFID-A** – **8DI-PD**

## Type code – explanation

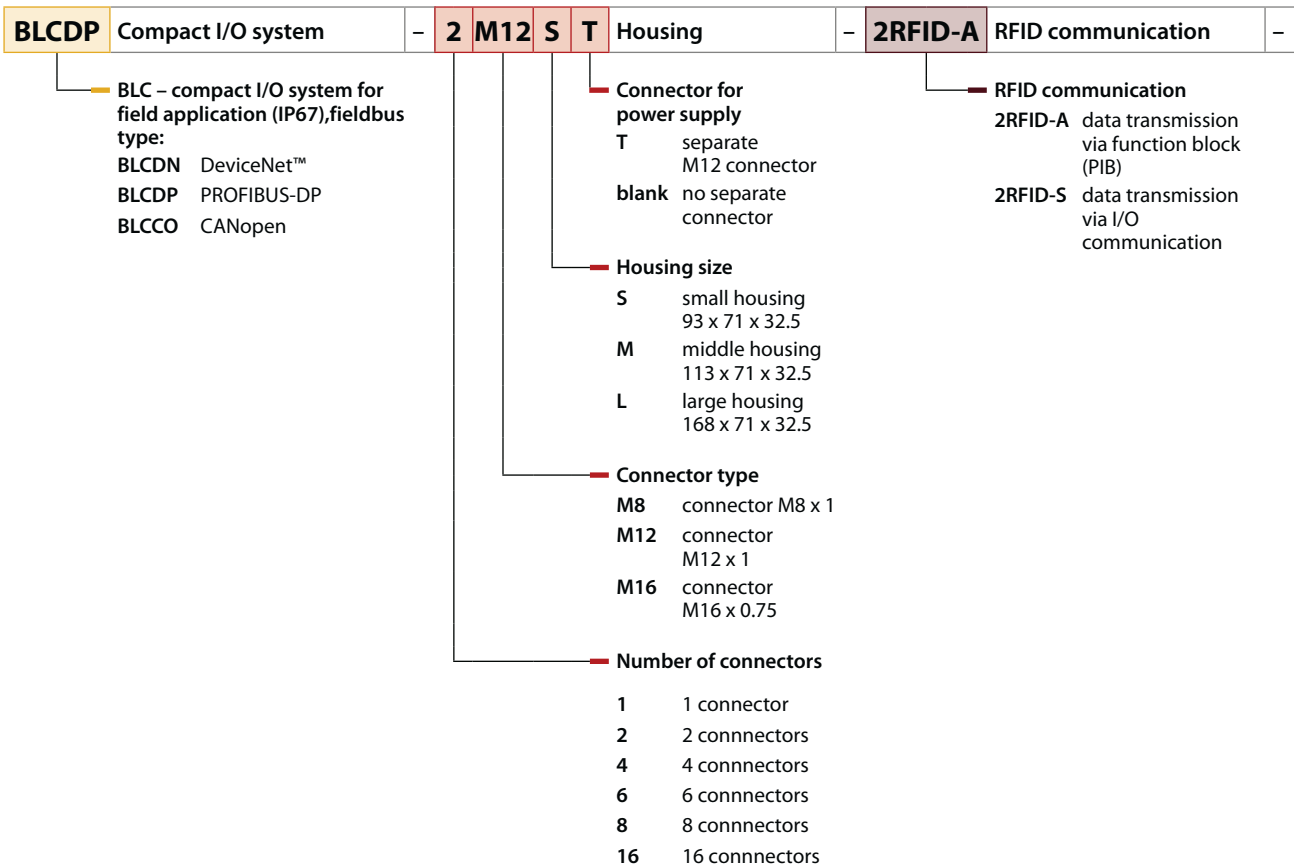

**8DI-PD** Inputs/Outputs

- Inputs/Outputs**
  - 8XSG-PD** 8 digital inputs/outputs, configurable, PNP, diagnostics
  - 8DI-PD** 8 digital inputs, PNP, diagnostics

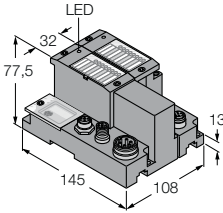
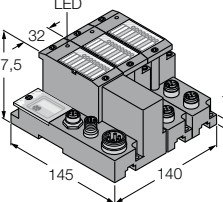
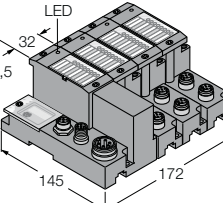
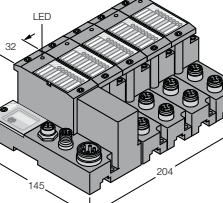
	Fieldbus	Number of channels	Ident no.	Type
	PROFIBUS-DP	2	1545028	<b>TI-BL67-DPV1-2</b>
	PROFIBUS-DP	2	1545106	<b>TI-BL67-DPV1-S-2</b>
	PROFIBUS-DP	4	1545029	<b>TI-BL67-DPV1-4</b>
	PROFIBUS-DP	4	1545107	<b>TI-BL67-DPV1-S-4</b>
	PROFIBUS-DP	6	1545030	<b>TI-BL67-DPV1-6</b>
	PROFIBUS-DP	6	1545108	<b>TI-BL67-DPV1-S-6</b>
	PROFIBUS-DP	8	1545031	<b>TI-BL67-DPV1-8</b>
	PROFIBUS-DP	8	1545109	<b>TI-BL67-DPV1-S-8</b>

**Wiring diagrams (page 122) read/write head HF und UHF:**

Cable type: S2500: w01 und w02  
 S2503: w03 und w04

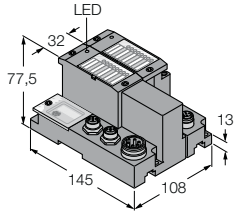
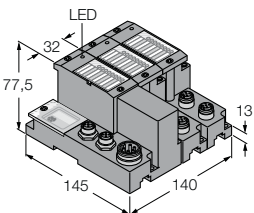
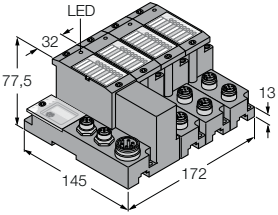
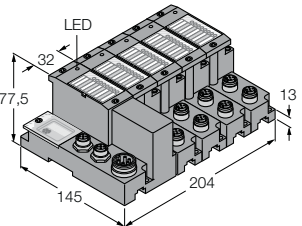
	Fieldbus	Number of channels	Ident no.	Type
	PROFIBUS-DP	2	1545061	<b>TI-BL67-PG-DP-2</b>
	PROFIBUS-DP	2	1545094	<b>TI-BL67-PG-DP-S-2</b>
	PROFIBUS-DP	4	1545062	<b>TI-BL67-PG-DP-4</b>
	PROFIBUS-DP	4	1545095	<b>TI-BL67-PG-DP-S-4</b>
	PROFIBUS-DP	6	1545063	<b>TI-BL67-PG-DP-6</b>
	PROFIBUS-DP	6	1545096	<b>TI-BL67-PG-DP-S-6</b>
	PROFIBUS-DP	8	1545064	<b>TI-BL67-PG-DP-8</b>
	PROFIBUS-DP	8	1545097	<b>TI-BL67-PG-DP-S-8</b>

**Wiring diagrams (page 122) read/write head HF und UHF:**

Cable type: S2500: w01 und w02  
S2503: w03 und w04

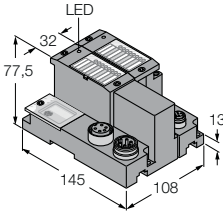
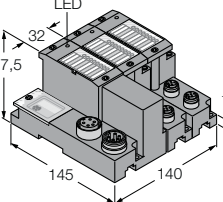
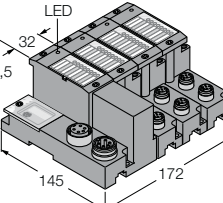
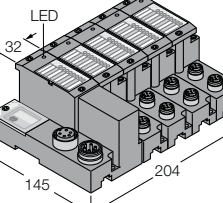
	<b>Fieldbus</b>	<b>Number of channels</b>	<b>Ident no.</b>	<b>Type</b>
	DeviceNet™	2	1545114	<b>TI-BL67-DN-S-2</b>
	DeviceNet™	4	1545115	<b>TI-BL67-DN-S-4</b>
	DeviceNet™	6	1545116	<b>TI-BL67-DN-S-6</b>
	DeviceNet™	8	1545117	<b>TI-BL67-DN-S-8</b>

**Wiring diagrams (page 122) read/write head HF und UHF:**

Cable type: S2500: w01 und w02  
 S2503: w03 und w04



	Fieldbus	Number of channels	Ident no.	Type
	Modbus TCP	2	1545150	TI-BL67-EN-S-2
	Modbus TCP	2	1545065	TI-BL67-PG-EN-2
	Modbus TCP	2	1545098	TI-BL67-PG-EN-S-2
	EtherNet/IP™	2	1545069	TI-BL67-PG-EIP-2
	EtherNet/IP™	2	1545102	TI-BL67-PG-EIP-S-2
	PROFINET IO (RT)	2	1545040	TI-BL67-EN-PN-2
	Modbus TCP	4	1545151	TI-BL67-EN-S-4
	Modbus TCP	4	1545066	TI-BL67-PG-EN-4
	Modbus TCP	4	1545099	TI-BL67-PG-EN-S-4
	EtherNet/IP™	4	1545070	TI-BL67-PG-EIP-4
	EtherNet/IP™	4	1545103	TI-BL67-PG-EIP-S-4
	PROFINET IO (RT)	4	1545041	TI-BL67-EN-PN-4
	Modbus TCP	6	1545152	TI-BL67-EN-S-6
	Modbus TCP	6	1545067	TI-BL67-PG-EN-6
	Modbus TCP	6	1545100	TI-BL67-PG-EN-S-6
	EtherNet/IP™	6	1545071	TI-BL67-PG-EIP-6
	EtherNet/IP™	6	1545104	TI-BL67-PG-EIP-S-6
	PROFINET IO (RT)	6	1545042	TI-BL67-EN-PN-6
	Modbus TCP	8	1545153	TI-BL67-EN-S-8
	Modbus TCP	8	1545068	TI-BL67-PG-EN-8
	Modbus TCP	8	1545101	TI-BL67-PG-EN-S-8
	EtherNet/IP™	8	1545072	TI-BL67-PG-EIP-8
	EtherNet/IP™	8	1545105	TI-BL67-PG-EIP-S-8
	PROFINET IO (RT)	8	1545043	TI-BL67-EN-PN-8

**Wiring diagrams (page 122) read/write head HF und UHF:**

Cable type: S2500: w01 und w02  
S2503: w03 und w04

	<b>Fieldbus</b>	<b>Number of channels</b>	<b>Ident no.</b>	<b>Type</b>
	PROFINET IO (RT)	2	1545168	<b>TI-BL67-PN-AC-S-2</b>
	PROFINET IO (RT)	4	1545169	<b>TI-BL67-PN-AC-S-4</b>
	PROFINET IO (RT)	6	1545170	<b>TI-BL67-PN-AC-S-6</b>
	PROFINET IO (RT)	8	1545171	<b>TI-BL67-PN-AC-S-8</b>

**Wiring diagrams (page 122) read/write head HF und UHF:**

Cable type: S2500: w01 und w02  
 S2503: w03 und w04

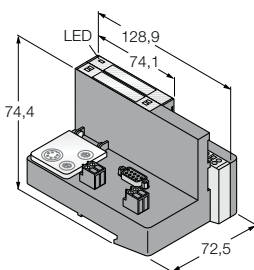
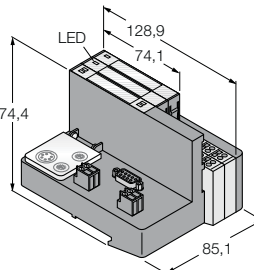
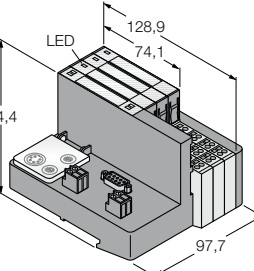
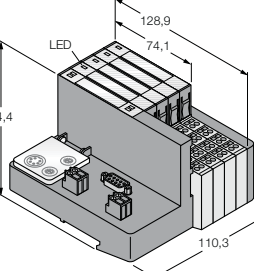
	Fieldbus	Number of channels	Ident no.	Type
	PROFIBUS-DP	2	1545004	<b>TI-BL20-DPV1-2</b>
	PROFIBUS-DP	2	1545074	<b>TI-BL20-DPV1-S-2</b>
	PROFIBUS-DP	4	1545005	<b>TI-BL20-DPV1-4</b>
	PROFIBUS-DP	4	1545075	<b>TI-BL20-DPV1-S-4</b>
	PROFIBUS-DP	6	1545006	<b>TI-BL20-DPV1-6</b>
	PROFIBUS-DP	6	1545076	<b>TI-BL20-DPV1-S-6</b>
	PROFIBUS-DP	8	1545007	<b>TI-BL20-DPV1-8</b>
	PROFIBUS-DP	8	1545077	<b>TI-BL20-DPV1-S-8</b>

**Wiring diagrams (page 122) read/write head HF:**

Cable type: S2500: w07 und w02  
S2503: w08 und w04

**Wiring diagrams (page 122) read/write head UHF:**

Cable type: S2500: w09 und w02  
S2503: w10 und w04

Interfaces (Sets) –  
HF and UHF

	<b>Fieldbus</b>	<b>Number of channels</b>	<b>Ident no.</b>	<b>Type</b>
	PROFIBUS-DP	2	1545122	<b>TI-BL20-E-DPV1-2</b>
	PROFIBUS-DP	2	1545126	<b>TI-BL20-E-DPV1-S-2</b>
	CANopen	2	1545134	<b>TI-BL20-E-CO-S-2</b>
	PROFIBUS-DP	4	1545123	<b>TI-BL20-E-DPV1-4</b>
	PROFIBUS-DP	4	1545127	<b>TI-BL20-E-DPV1-S-4</b>
	CANopen	4	1545135	<b>TI-BL20-E-CO-S-4</b>
	PROFIBUS-DP	6	1545124	<b>TI-BL20-E-DPV1-6</b>
	PROFIBUS-DP	6	1545128	<b>TI-BL20-E-DPV1-S-6</b>
	CANopen	6	1545136	<b>TI-BL20-E-CO-S-6</b>
	PROFIBUS-DP	8	1545125	<b>TI-BL20-E-DPV1-8</b>
	PROFIBUS-DP	8	1545129	<b>TI-BL20-E-DPV1-S-8</b>
	CANopen	8	1545137	<b>TI-BL20-E-CO-S-8</b>

**Wiring diagrams (page 122) read/write head HF:**

Cable type: S2500: w07 und w02  
 S2503: w08 und w04

**Wiring diagrams (page 122) read/write head UHF:**

Cable type: S2500: w09 und w02  
 S2503: w10 und w04

	Fieldbus	Number of channels	Ident no.	Type
	DeviceNet™	2	1545078	TI-BL20-DN-S-2
	DeviceNet™	4	1545079	TI-BL20-DN-S-4
	DeviceNet™	6	1545080	TI-BL20-DN-S-6
	DeviceNet™	8	1545081	TI-BL20-DN-S-8

**Wiring diagrams (page 122) read/write head HF:**

Cable type: S2500: w07 und w02  
S2503: w08 und w04

**Wiring diagrams (page 122) read/write head UHF:**

Cable type: S2500: w09 und w02  
S2503: w10 und w04

	<b>Fieldbus</b>	<b>Number of channels</b>	<b>Ident no.</b>	<b>Type</b>
	DeviceNet™	2	1545130	<b>TI-BL20-E-DN-S-2</b>
	DeviceNet™	4	1545131	<b>TI-BL20-E-DN-S-4</b>
	DeviceNet™	6	1545132	<b>TI-BL20-E-DN-S-6</b>
	DeviceNet™	8	1545133	<b>TI-BL20-E-DN-S-8</b>

**Wiring diagrams (page 122) read/write head HF:**

Cable type: S2500: w07 und w02  
 S2503: w08 und w04

**Wiring diagrams (page 122) read/write head UHF:**

Cable type: S2500: w09 und w02  
 S2503: w10 und w04

	Fieldbus	Number of channels	Ident no.	Type
	Modbus TCP	2	1545138	TI-BL20-EN-S-2
	Modbus TCP	2	1545053	TI-BL20-PG-EN-2
	Modbus TCP	2	1545086	TI-BL20-PG-EN-S-2
	EtherNet/IP™	2	1545082	TI-BL20-EIP-S-2
	EtherNet/IP™	2	1545057	TI-BL20-PG-EIP-2
	EtherNet/IP™	2	1545090	TI-BL20-PG-EIP-S-2
	Modbus TCP	4	1545139	TI-BL20-EN-S-4
	Modbus TCP	4	1545054	TI-BL20-PG-EN-4
	Modbus TCP	4	1545087	TI-BL20-PG-EN-S-4
	EtherNet/IP™	4	1545083	TI-BL20-EIP-S-4
	EtherNet/IP™	4	1545058	TI-BL20-PG-EIP-4
	EtherNet/IP™	4	1545091	TI-BL20-PG-EIP-S-4
	Modbus TCP	6	1545140	TI-BL20-EN-S-6
	Modbus TCP	6	1545055	TI-BL20-PG-EN-6
	Modbus TCP	6	1545088	TI-BL20-PG-EN-S-6
	EtherNet/IP™	6	1545084	TI-BL20-EIP-S-6
	EtherNet/IP™	6	1545059	TI-BL20-PG-EIP-6
	EtherNet/IP™	6	1545092	TI-BL20-PG-EIP-S-6
	Modbus TCP	8	1545141	TI-BL20-EN-S-8
	Modbus TCP	8	1545056	TI-BL20-PG-EN-8
	Modbus TCP	8	1545089	TI-BL20-PG-EN-S-8
	EtherNet/IP™	8	1545085	TI-BL20-EIP-S-8
	EtherNet/IP™	8	1545060	TI-BL20-PG-EIP-8
	EtherNet/IP™	8	1545093	TI-BL20-PG-EIP-S-8

**Wiring diagrams (page 122) read/write head HF:**

Cable type: S2500: w07 und w02  
S2503: w08 und w04

**Wiring diagrams (page 122) read/write head UHF:**

Cable type: S2500: w09 und w02  
S2503: w10 und w04

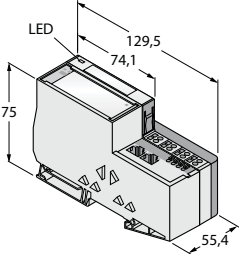
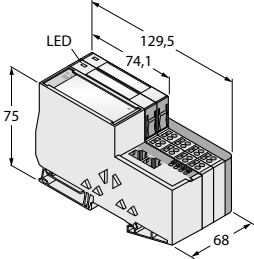
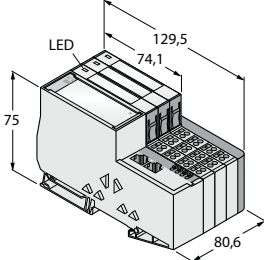
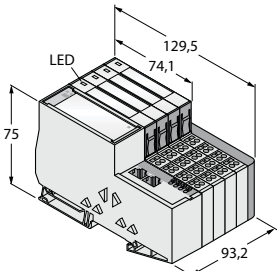
	Fieldbus	Number of channels	Ident no.	Type
	PROFINET IO (IRT)	2	7030467	<b>TI-BL20-E-PN-2</b>
	PROFINET IO (IRT)	2	7030471	<b>TI-BL20-E-PN-S-2</b>
	EtherCAT®	2	7030479	<b>TI-BL20-E-EC-S-2</b>
	PROFINET IO (IRT)	4	7030468	<b>TI-BL20-E-PN-4</b>
	PROFINET IO (IRT)	4	7030472	<b>TI-BL20-E-PN-S-4</b>
	EtherCAT®	4	7030480	<b>TI-BL20-E-EC-S-4</b>
	PROFINET IO (IRT)	6	7030469	<b>TI-BL20-E-PN-6</b>
	PROFINET IO (IRT)	6	7030473	<b>TI-BL20-E-PN-S-6</b>
	EtherCAT®	6	7030481	<b>TI-BL20-E-EC-S-6</b>
	PROFINET IO (IRT)	8	7030470	<b>TI-BL20-E-PN-8</b>
	PROFINET IO (IRT)	8	7030474	<b>TI-BL20-E-PN-S-8</b>
	EtherCAT®	8	7030482	<b>TI-BL20-E-EC-S-8</b>

**Wiring diagrams (page 122) read/write head HF:**

Cable type: S2500: w07 und w02  
 S2503: w08 und w04

**Wiring diagrams (page 122) read/write head UHF:**

Cable type: S2500: w09 und w02  
 S2503: w10 und w04

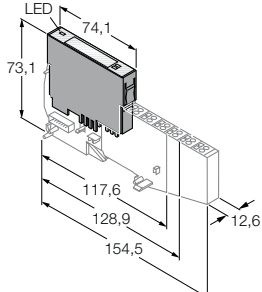
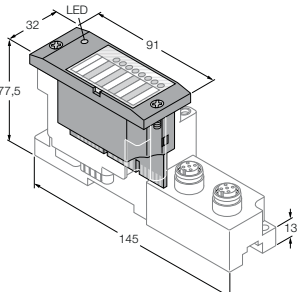
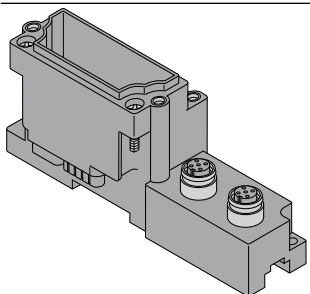
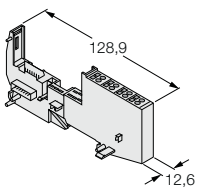

	Fieldbus	Number of channels	Ident no.	Type
	PROFIBUS-DP DeviceNet™ CANopen Modbus TCP PROFINET IO (RT) EtherNet/IP™	2	6827306	<b>BL20-2RFID-S</b>
	PROFIBUS-DP Modbus TCP PROFINET IO (RT) EtherNet/IP™	2	6827233	<b>BL20-2RFID-A</b>
	PROFIBUS-DP DeviceNet™ CANopen Modbus TCP PROFINET IO (RT) EtherNet/IP™	2	6827305	<b>BL67-2RFID-S</b>
	PROFIBUS-DP Modbus TCP PROFINET IO (RT) EtherNet/IP™	2	6827225	<b>BL67-2RFID-A</b>
	–	–	6827186	<b>BL67-B-2M12</b>
	–	–	6827046	<b>BL20-S4T-SBBS</b>

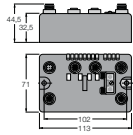
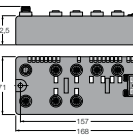
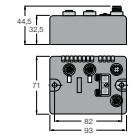
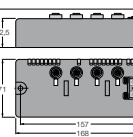
	<b>Fieldbus</b>	<b>Number of channels</b>	<b>Ident no.</b>	<b>Type</b>
	PROFIBUS-DP	2	6811166	BLCDP-2M12MT-2RFID-A
	PROFIBUS-DP	2	6811177	BLCDP-2M12MT-2RFID-S
	PROFIBUS-DP	2	6811174	BLCDP-6M12LT-2RFID-A-8XSG-PD
	DeviceNet™	2	6811049	BLCDN-6M12LT-2RFID-S-8XSG-PD
	PROFIBUS-DP	2	6811173	BLCDP-6M12LT-2RFID-A-8DI-PD
	PROFIBUS-DP	2	6811179	BLCDP-6M12LT-2RFID-S-8XSG-PD
	PROFIBUS-DP	2	6811178	BLCDP-6M12LT-2RFID-S-8DI-PD
	CANopen	2	6811303	BLCCO-6M12LT-2RFID-S-8XSG-P
	DeviceNet™	2	6811002	BLCDN-2M12S-2RFID-S
	CANopen	2	6811300	BLCCO-2M12S-2RFID-S
	DeviceNet™	4	6811055	BLCDN-4M12L-2RFID-S-2RFID-S





# Connectivity solutions – HF and UHF



## BL ident® RFID cables – HF/UHF

We provide ready-made *BL ident*® extension cables for safe communication between interface and read/write head. They are optimally adapted to the individual components and thus guarantee safe operation of the entire system. The standard versions (...S2500) are suited for all standard tasks of highly complex applications; the economy versions (...S2503) convince through a good price/performance ratio and are best suited for high demands.

For extreme environmental conditions we offer the FB-... series. Through combination with read/write heads of the Wash-Down series, the FB cables achieve IP69K rating. This opens up new fields of application for *BL ident*® such as the food industry for example.

The TURCK product portfolio also comprises ready-made bus and supply cables which help you to reduce wiring errors.



Scan the QR code to access our products on the internet

# Type code

## Type code – example

... - **RK4.5T** - **5** / **S2500**

## Type code – explanation

...	Usage	-	<b>RK4.5T</b>	Connector type	-	<b>5</b>	Cable length	/
	Usage			Connector type			Cable length	
	FB-			RK4.5T		0.3	0.3 m	
				WK4.5T		2	2 m	
				RS4.5T		5	5 m	
						10	10 m	
						25	25 m	
						50	50 m	

**S2500** Connector quality

### Connector quality

- S2500** standard version:  
cable: UL 20963; cable jacket:  
PUR, yellow, qualified for  
drag chain use, oil-resistant,  
highly flexible
- S2503** economic version:  
cable: UL 20549; cable jacket:  
PUR, black; qualified for  
drag chain use, oil-resistant,  
flexible



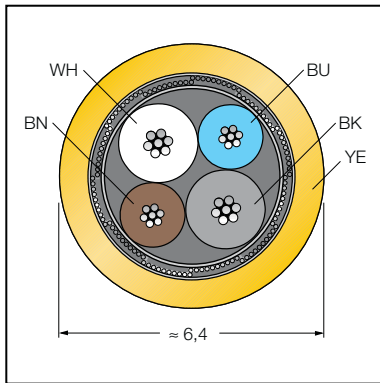

- 4-pin, AWG 224 / AWG 22
- Sheath material: PUR jacket, yellow
- Halogen and LABS free
- Shield: Aluminium foil, tinned copper braid
- Sheath diameter: 6.4 mm
- Qualified for drag chain use, oil-resistant, highly flexible
- Cable UL Style 20963

<b>Cable type</b>	S2500
Cable jacket	PUR, yellow
Cable diameter	Ø 6.4 mm
Shield	yes
Core cross-section	2 x 0.2 mm <sup>2</sup>
DC resistance (loop)	103 Ω /km
Core cross-section	2 x 0.34 mm <sup>2</sup>
Trailing capability	yes
halogen-free	yes
<hr/>	
<b>Connector A side</b>	male/female, M12 x 1, straight/ angled
Types	RK4.5T, RS4.5T, WK4.5T
Number of pins	5
Contacts	metal, CuZn, gold-plated
Contact carriers	plastic, CuZn, black
Grip	plastic, TPU, black
Coupling nut/screw	metal, CuZn-Ni, nickel-plated
Protection class	IP67
<hr/>	
<b>Rated voltage [U<sub>max</sub>]</b>	30 V
Ambient temperature	
Stationary usage	-40 ... 90 °C
Non-stationary usage	-25 ... 90 °C

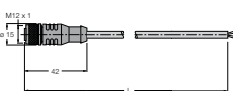
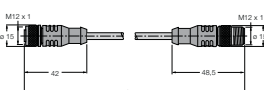
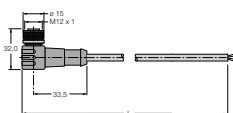
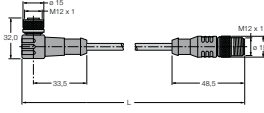

	Cable length [m]	Wiring diagram male	Wiring diagram female	Ident no.	Type
	100	–	–	8036048	KABEL-BLIDENT-100M
	2	–	w05	8035244	RK4.5T-2/S2500
	5	–	w05	6699206	RK4.5T-5/S2500
	10	–	w05	6699207	RK4.5T-10/S2500
	25	–	w05	6638421	RK4.5T-25/S2500
	50	–	w05	6699422	RK4.5T-50/S2500
	0.3	w02	w05	6699210	RK4.5T-0,3-RS4.5T/S2500
	2	w02	w05	6699200	RK4.5T-2-RS4.5T/S2500
	5	w02	w05	6699201	RK4.5T-5-RS4.5T/S2500
	10	w02	w05	6699202	RK4.5T-10-RS4.5T/S2500
	25	w02	w05	6699211	RK4.5T-25-RS4.5T/S2500
	50	w02	w05	8035246	RK4.5T-50-RS4.5T/S2500
	2	–	w05	8035245	WK4.5T-2/S2500
	5	–	w05	6699208	WK4.5T-5/S2500
	10	–	w05	6699209	WK4.5T-10/S2500
	25	–	w05	6699423	WK4.5T-25/S2500
	50	–	w05	6699424	WK4.5T-50/S2500
	2	w02	w05	6699203	WK4.5T-2-RS4.5T/S2500
	5	w02	w05	6699204	WK4.5T-5-RS4.5T/S2500
	10	w02	w05	6699205	WK4.5T-10-RS4.5T/S2500
	25	w02	w05	6638425	WK4.5T-25-RS4.5T/S2500
	50	w02	w05	6638426	WK4.5T-50-RS4.5T/S2500

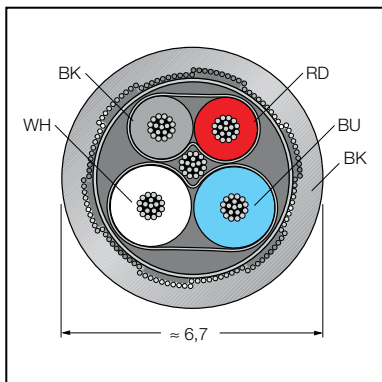

- 4-pin, AWG 19/24 (data line), AWG 19/22 (supply line)
- Sheath material: PUR jacket, black
- Halogen and LABS free
- Shield: Aluminium foil, tinned copper braid
- Sheath diameter: 6.7 mm
- Qualified for drag chain use, oil-resistant, highly flexible
- Cable UL Style 20549

<b>Cable type</b>	S2503
Cable jacket	PUR, black
Cable diameter	Ø 6.7 mm
Shield	yes
Core cross-section	2 x 0.25 mm <sup>2</sup>
DC resistance (loop)	164 Ω /km
Core cross-section	2 x 0.34 mm <sup>2</sup>
Trailing capability	yes
<hr/>	
<b>Connector A side</b>	male/female, M12 x 1, straight/ angled
Types	RK4.5T, RS4.5T, WK4.5T
Number of pins	5
Contacts	metal, CuZn, gold-plated
Contact carriers	plastic, CuZn, black
Grip	plastic, TPU, black
Coupling nut/screw	metal, CuZn-Ni, nickel-plated
Protection class	IP67
<hr/>	
<b>Rated voltage [U<sub>max</sub>]</b>	300 V
Ambient temperature	
Stationary usage	-50 ... 80 °C
Non-stationary usage	-25 ... 80 °C

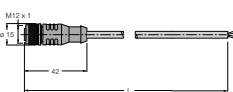
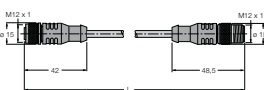
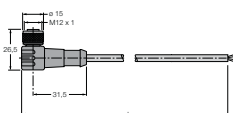
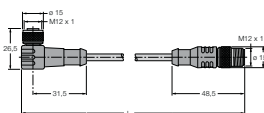
	Cable length [m]	Wiring diagram male	Wiring diagram female	Ident no.	Type
	100	–	–	7030351	KABEL-E-BLIDENT-100M
	2	–	w06	7030341	RK4.5T-2/S2503
	5	–	w06	7030342	RK4.5T-5/S2503
	10	–	w06	7030343	RK4.5T-10/S2503
	25	–	w06	7030344	RK4.5T-25/S2503
	50	–	w06	7030345	RK4.5T-50/S2503
	2	w04	w06	7030331	RK4.5T-2-RS4.5T/S2503
	5	w04	w06	7030332	RK4.5T-5-RS4.5T/S2503
	10	w04	w06	7030333	RK4.5T-10-RS4.5T/S2503
	25	w04	w06	7030334	RK4.5T-25-RS4.5T/S2503
	50	w04	w06	7030335	RK4.5T-50-RS4.5T/S2503
	2	–	w06	7030346	WK4.5T-2/S2503
	5	–	w06	7030347	WK4.5T-5/S2503
	10	–	w06	7030348	WK4.5T-10/S2503
	25	–	w06	7030349	WK4.5T-25/S2503
	50	–	w06	7030350	WK4.5T-50/S2503
	2	w04	w06	7030336	WK4.5T-2-RS4.5T/S2503
	5	w04	w06	7030337	WK4.5T-5-RS4.5T/S2503
	10	w04	w06	7030338	WK4.5T-10-RS4.5T/S2503
	25	w04	w06	7030339	WK4.5T-25-RS4.5T/S2503
	50	w04	w06	7030340	WK4.5T-50-RS4.5T/S2503

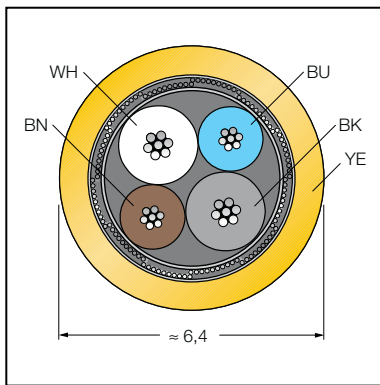

- The new standard for the food industry
- Resistant to all common acid and alkaline detergents and disinfectants
- Protection classes IP67 and IP69K
- No hardening, no discoloration due to detergent resistant PVC free plastics
- Also available in other cable lengths

<b>Cable type</b>	PP
Cable jacket	PP, yellow
Cable diameter	Ø 6.4 mm
Core cross-section	0.25 mm <sup>2</sup>
Core cross-section	0.34 mm <sup>2</sup>
<b>Connector A side</b>	female connector, M12 x 1, straight/ angled
Types	RK4.5T, WK4.5T
Number of pins	5
Contacts	metal, CuZn, gold-plated
Contact carriers	plastic, CuZn, black
Grip	PP, white
Coupling nut/screw	stainless steel, 1.4404
Ampacity	4 A
Protection class	IP67, IP69K, (screwed together)
<b>Rated voltage [U<sub>max</sub>]</b>	250 V
Ambient temperature	
Non-stationary usage	-25 ... 90 °C

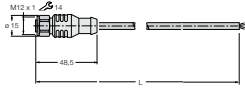
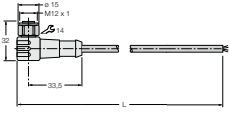
	Cable length [m]	Wiring diagram femal	Ident no.	Type
	5	w05	7030281	FB-RK4.5T-5/S2500
	10	w05	7030282	FB-RK4.5T-10/S2500
	25	w05	7030283	FB-RK4.5T-25/S2500
	50	w05	7030284	FB-RK4.5T-50/S2500
	5	w05	7030285	FB-WK4.5T-5/S2500
	10	w05	7030286	FB-WK4.5T-10/S2500
	25	w05	7030287	FB-WK4.5T-25/S2500
	50	w05	7030288	FB-WK4.5T-50/S2500

Connectivity solutions –  
HF and UHF



# Accessories – HF and UHF



## **BL ident® accessories – HF/UHF**

We offer the matching accessories for the read/write heads and data carriers. Mounting adapters for read/write heads and data carriers, also labels and protective frames for the data carriers.



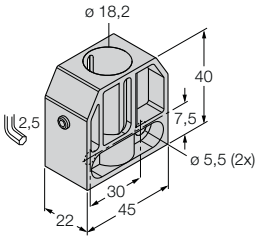
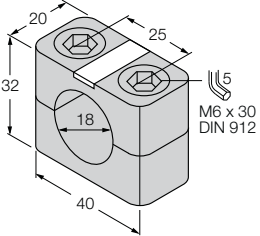
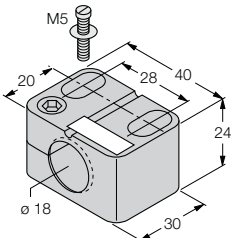
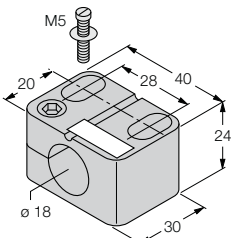

## **BL ident® mobile handhelds – HF/UHF**

TURCK offers industrial-suited handhelds for mobile reading and writing of data carriers suited for HF and UHF applications. The data is displayed on a touch screen and can be edited and written on data carriers if wanted. On request, we deliver them with Bluetooth, WLAN, bar-code scanner and application software.

	<b>Housing quality</b>	<b>Description</b>	<b>Ident no.</b>	<b>Type</b>
	PA	▪ Mounting bracket for threaded barrel devices; material: PA66-GF	69471	<b>BS 18</b>
	PBT	▪ Fixing clamp; material: PA66-GF	69472	<b>BSN 18</b>
	PA	▪ Fixing clamp for threaded barrel devices, with dead-stop; material: PA6	6947214	<b>BST-18B</b>
	PA	▪ Fixing clamp for threaded barrel devices, without dead-stop; material: PA6	6947215	<b>BST-18N</b>

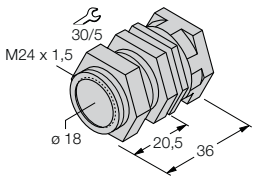
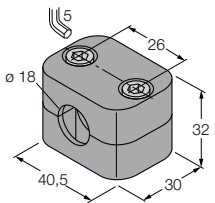
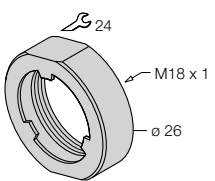
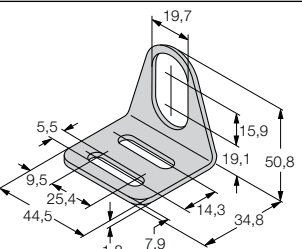

	Housing quality	Description	Ident no.	Type
	CuZn	<p>▪ Quick-mount bracket with dead-stop; material: Chrome-plated brass Male thread M24 x 1.5. Note: The switching distance of proximity switches can be reduced by the use of quick-mount brackets.</p>	6945102	<b>QM-18</b>
	PP	<p>▪ Mounting bracket for smooth and threaded barrel devices; material: Polypropylene</p>	6901320	<b>BSS-18</b>
	VA	<p>▪ Protective nut for M18 x 1 threaded barrels; material: Stainless steel A2 1.4305 (AISI 303)</p>	6905310	<b>PN-M18</b>
	VA	<p>▪ Mounting bracket for threaded barrel devices; material: Stainless steel A2 1.4301 (AISI 304)</p>	6945004	<b>MW-18</b>

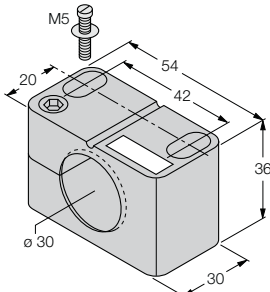
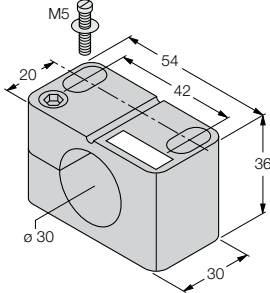
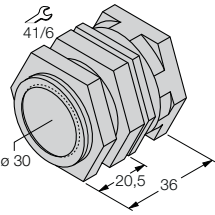
Housing quality	Description	Ident no.	Type
	<p>▪ PTFE-coated caps; for use in welding systems and grinding machinery; protection against intense sparking</p>	69663	<b>SKN/M18</b>
	<p>▪ Fixing clamp for threaded barrel devices, with dead-stop; material: PA6</p>	6947216	<b>BST-30B</b>
	<p>▪ Fixing clamp for threaded barrel devices, without dead-stop; material: PA6</p>	6947217	<b>BST-30N</b>
	<p>▪ Quick-mount bracket with dead-stop; material: Chrome-plated brass Male thread M36 x 1.5. Note: The switching distance of proximity switches can be reduced by the use of quick-mount brackets.</p>	6945103	<b>QM-30</b>

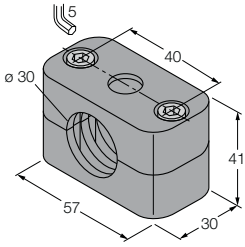
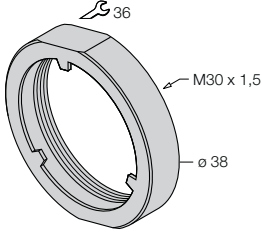
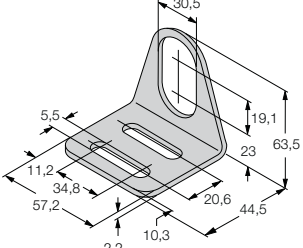
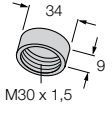
	Housing quality	Description	Ident no.	Type
	PP	▪ Mounting bracket for smooth and threaded barrel devices; material: Polypropylene	6901319	<b>BSS-30</b>
	VA	▪ Protective nut for M30 x 1 threaded barrel devices; material: Stainless steel A2 1.4305 (AISI 303)	6905308	<b>PN-M30</b>
	VA	▪ Mounting bracket for threaded barrel devices; material: Stainless steel A2 1.4301 (AISI 304)	6945005	<b>MW-30</b>
	PTFE	▪ PTFE-coated caps; for use in welding systems and grinding machinery; protection against intense sparking	69664	<b>SKN/M30</b>

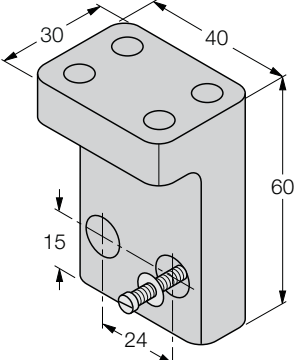
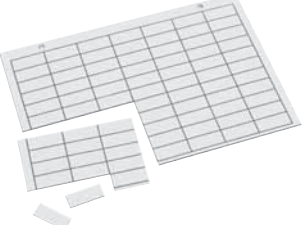
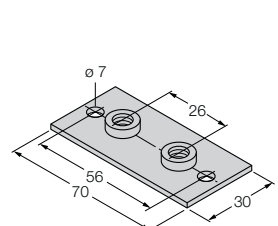
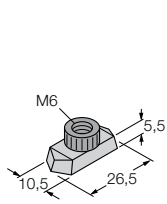
	<b>Housing quality</b>	<b>Description</b>	<b>Ident no.</b>	<b>Type</b>
	PA	▪ Base part for BST-12 and BST-18 fixing clamps	6947219	<b>BST-UH</b>
	PA	▪ Label for BST	6947220	<b>BST-BS</b>
	ST 37	▪ Weld-on plate for BSS mounting bracket, long	6901316	<b>BSS-SPV2</b>
	–	▪ DIN rail nut for BSS mounting bracket	6901323	<b>BSS-TSM (2 pcs.)</b>

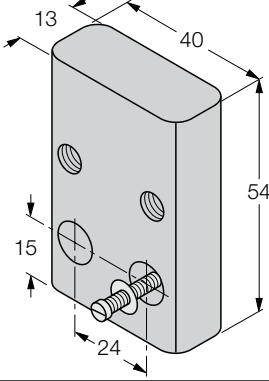
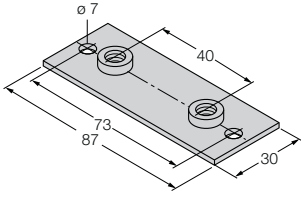
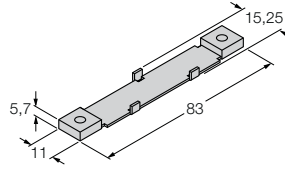
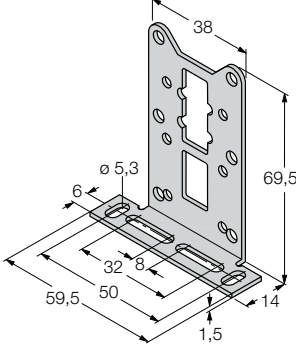
	<b>Housing quality</b>	<b>Description</b>	<b>Ident no.</b>	<b>Type</b>
	PA	▪ Base part for BST-12 and BST-18 fixing clamps	6947218	<b>BST-UV</b>
	ST 37	▪ Weld-on plate for BSS mounting bracket, long	6901347	<b>BSS-SPV4</b>
	–	▪ Metal clip with clamp magnets, mounting accessories for data carrier TWxxx-Q14L60-M-B110	7030377	<b>TH-Q14L60</b>
	VA	▪ Mounting bracket for rectangular Q14 or Q20; material VA 1.4301	6945006	<b>MW-Q14/Q20</b>

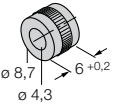
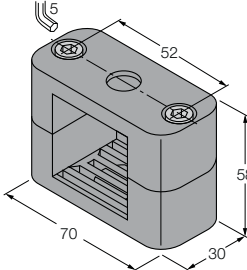
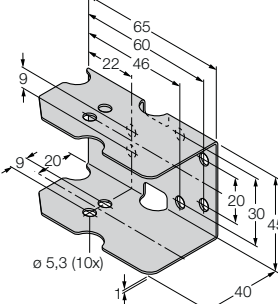
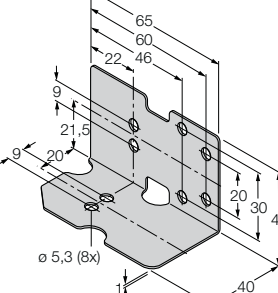
	<b>Housing quality</b>	<b>Description</b>	<b>Ident no.</b>	<b>Type</b>
	CuZn	▪ Mounted with active face downwards, for Q14	6950011	<b>MH-Q14</b>
	PP	▪ Mounting bracket for rectangular devices; material: Polypropylene	6901318	<b>BSS-CP40</b>
	VA	▪ Protective frame (U profile) CK40	6900483	<b>MF-CK40-3S</b>
	VA	▪ Protective frame (angle) for rectangular CK40	6900482	<b>MF-CK40-2S</b>

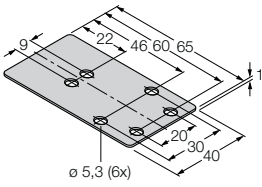
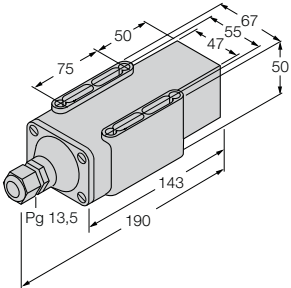
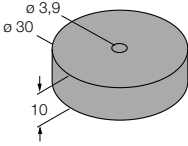
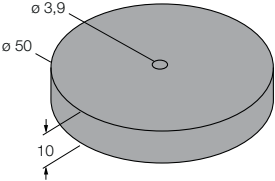
Housing quality	Description	Ident no.	Type
	<p>▪ Protective frame (one side) rectangular CK40</p>	6900481	<b>MF-CK40-1S</b>
	<p>▪ Protective frame for rectangular CP40; material housing/cover: ULTEM; temperature resistant up to +170 °C, especially UV and ozone resistant; protection class IP 68, 5 m w.g.</p>	69497	<b>SG40/2 (ULTEM)</b>
	<p>▪ Spacer for indirect mounting of data carriers on metal.</p>	6900512	<b>DS-R30</b>
	<p>▪ Spacer for indirect mounting of data carriers on metal</p>	6900386	<b>DS-R50</b>

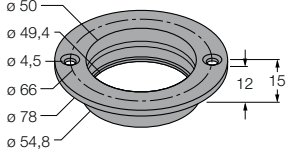
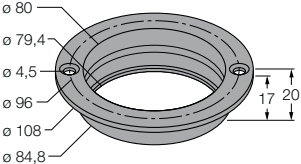
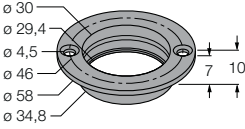
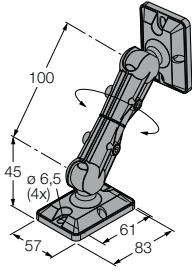
	Housing quality	Description	Ident no.	Type
	-	<ul style="list-style-type: none"> <li>▪ The flange facilitates mounting of the data carrier TW-R50-M-B128 (-K2) on or in the metal.</li> </ul>	6901151	<b>MF-R50</b>
	-	<ul style="list-style-type: none"> <li>▪ The flange facilitates mounting of the data carrier TW-R80-M-B128 (-K2) on or in metal.</li> </ul>	6901152	<b>MF-R80</b>
	-	<ul style="list-style-type: none"> <li>▪ The flange facilitates mounting of the data carrier TW-R30-M-B128 (-K2) on or in the metal.</li> </ul>	6901150	<b>MF-R30</b>
	-	<ul style="list-style-type: none"> <li>▪ Arm bracket for UHF RFID read/write heads TNxxx-Q175L200-H1147, TNxxx-Q240L280-H1147 and TNxxx-Q280L640-H1147</li> </ul>	7030296	<b>RH-Q240L280/ Q280L640</b>



	Operating frequency [MHz]	Electrical features	Ident no.	Type
	13.56	<ul style="list-style-type: none"> <li>▪ Mobile handheld with HF antenna</li> <li>▪ Incl. TURCK RFID software for reading and writing of data</li> <li>▪ Display of decimal, binary, hexadecimal and ASCII codes</li> <li>▪ With RS232 interface</li> <li>▪ Fold-out antenna</li> <li>▪ Protection class IP65</li> <li>▪ Incl. docking station with power supply</li> </ul>	1542331	<b>PD-IDENT</b>
	13.56	<ul style="list-style-type: none"> <li>▪ Mobile handheld with HF antenna</li> <li>▪ Incl. TURCK RFID software for reading and writing of data</li> <li>▪ Display of decimal, binary, hexadecimal and ASCII codes</li> <li>▪ RS232 interface</li> <li>▪ With WLAN function</li> <li>▪ Fold-out antenna</li> <li>▪ Protection class IP65</li> <li>▪ Incl. docking station with power supply</li> </ul>	1542340	<b>PD-IDENT-WLAN</b>
	–	<ul style="list-style-type: none"> <li>▪ Mobile handheld, PDA-type</li> <li>▪ Display of decimal, binary, hexadecimal and ASCII codes</li> <li>▪ Incl. TURCK RFID software for reading and writing of data</li> <li>▪ WLAN and Bluetooth</li> <li>▪ Incl. docking station with power supply</li> <li>▪ PDA-IDENT-IA antenna, for use with RFID</li> </ul>	1542344	<b>PDA-IDENT</b>
	13.56	<ul style="list-style-type: none"> <li>▪ Internal antenna (CF-card) for use with PDA-Ident</li> </ul>	1542345	<b>PDA-IDENT-IA</b>

	Operating frequency [MHz]	Electrical features	Ident no.	Type
	13.56	<ul style="list-style-type: none"> <li>▪ Mobile handheld with HF antenna</li> <li>▪ 1D laser scanner for barcodes</li> <li>▪ Keyboard function (HID) for wireless transfer of read data via Bluetooth</li> <li>▪ Incl. docking station with power supply, PC data interface via USB cable</li> <li>▪ Pistol grip</li> <li>▪ Optionally available on request: Barcode 1D or 2D imager</li> <li>▪ Optionally available on request: WLAN</li> </ul>	7030461	<b>PD-IDENT-HF-RBSUP</b>
	868	<ul style="list-style-type: none"> <li>▪ Mobile handheld with UHF antenna</li> <li>▪ Incl. docking station with power supply, PC data interface via USB cable</li> <li>▪ Pistol grip</li> <li>▪ Optionally available on request: Barcode scanner (1D / 2D imager or 1D laser)</li> <li>▪ Optionally available on request: Bluetooth and WLAN</li> </ul>	7030422	<b>PD-IDENT-UHF-RUP-868</b>
	13.56	<ul style="list-style-type: none"> <li>▪ Mobile handheld with HF antenna</li> <li>▪ Keyboard function (HID) for wireless transfer of read data via Bluetooth or USB</li> <li>▪ With only three keys very easy to use</li> <li>▪ Incl. power supply unit, battery and bracket</li> <li>▪ Optionally available on request: Barcode 1D laser, 1D or 2D imager</li> </ul>	7030525	<b>PD-IDENT-HF-RBUP-SMART</b>

	Operating frequency [MHz]	Electrical features	Ident no.	Type
	13.56	<ul style="list-style-type: none"> <li>▪ Mobile handheld with HF antenna</li> <li>▪ Microsoft Windows CE 5</li> <li>▪ Customized software solution on request</li> <li>▪ Bluetooth</li> <li>▪ Protection class IP65</li> <li>▪ Incl. docking station with power supply, USB cable</li> <li>▪ Optionally available on request: Barcode scanner (1D / 2D imager or 1D laser)</li> <li>▪ Optionally available on request: WLAN, 4400 mAh battery and software development kit (SDK)</li> </ul>	7030499	<b>PD-IDENT-HF-RBTW</b>
	868	<ul style="list-style-type: none"> <li>▪ Mobile handheld with UHF antenna</li> <li>▪ Microsoft Windows CE 5</li> <li>▪ Customized software solution on request</li> <li>▪ Bluetooth</li> <li>▪ Protection class IP65</li> <li>▪ Incl. docking station with power supply, USB cable</li> <li>▪ Optionally available on request: Barcode scanner (1D / 2D imager or 1D laser)</li> <li>▪ Optionally available on request: WLAN, 4400 mAh battery and software development kit (SDK)</li> </ul>	7030421	<b>PD-IDENT-UHF-RBTW-868</b>
	915...920	<ul style="list-style-type: none"> <li>▪ Mobile handheld with UHF antenna</li> <li>▪ Microsoft Windows CE 5</li> <li>▪ Customized software solution on request</li> <li>▪ Bluetooth</li> <li>▪ Protection class IP65</li> <li>▪ Incl. docking station with power supply, USB cable</li> <li>▪ Optionally available on request: Barcode scanner (1D / 2D imager or 1D laser)</li> <li>▪ Optionally available on request: WLAN, 4400 mAh battery and software development kit (SDK)</li> </ul>	7030514	<b>PD-IDENT-UHF-RBTW-915-920</b>



# Read/write heads and data carriers – HF



## BL ident® read/write heads and data carriers – HF

RFID systems transmitting at 13.56 MHz (HF) are almost insensitive to electromagnetic disturbance. This frequency band has become standard in many RFID application areas, especially in the industrial sector. Data carriers are interoperable and can be combined flexibly, thanks to the international radio transmission protocol ISO 15693. *BL ident®* HF devices achieve transmission ranges of up to 100 cm, depending on the combination of read/write head and data carrier used. This means high operational safety for automated processes where data carriers are constantly in motion, and it also pro-

vides high flexibility for manually executed identification tasks. The data carriers are entirely maintenance-free, thanks to power supplied passively via the read/write head's electromagnetic field. The radio interface for read/write heads and data carriers meets international uniform standards, allowing for all our *BL ident®* HF components to be installed in any application worldwide. You find the table with combination possibilities and achievable ranges of TURCK read/write heads and data carriers on page 86 ff.



Scan the QR code to access our products on the internet

# Type code – HF and UHF

## Type code – example

T	N	LR	...	-	Q80	-	H1147	-	S	-	Ex
---	---	----	-----	---	-----	---	-------	---	---	---	----

## Type code – explanation

T	N	LR	...	Read/write head	-	Q80	Housing	-	H1147	Connector type	/
				<ul style="list-style-type: none"> <li><b>Working frequency</b></li> <li>blank 13.56 MHz</li> <li>865 865...868 MHz</li> <li>902 902...928 MHz</li> <li>840/ 840.5...844.5 MHz &amp; 920.5...924.5 MHz</li> <li>920 920.5...924.5 MHz</li> <li>902/ 902...907 MHz &amp; 915...928 MHz</li> <li>915 915...928 MHz</li> <li>917 917...920.8 MHz</li> <li><b>Special range</b></li> <li>ER extended range</li> <li>LR long range</li> <li>SLR super long range</li> <li><b>Read/write heads, mounting condition</b></li> <li>B flush mountable</li> <li>N non-flush mountable</li> <li><b>TURCK RFID-System</b> BL ident®</li> </ul>		<ul style="list-style-type: none"> <li><b>Housing</b></li> <li>M18 thread M18</li> <li>M30 thread M30</li> <li>Q14 rectangular 55.5 x 30 x 14 mm</li> <li>CK40 rectangular 40 x 40 x 65 mm, variable orientation of active face</li> <li>Q80 rectangular, 114 x 80 x 40 mm</li> <li>S32XL ring shaped, 180 x 120 x 32 mm</li> <li>Q350 rectangular, 370 x 350 x 20 mm</li> <li>Q80L400 rectangular, 400 x 80 x 25 mm</li> <li>Q120L130 rectangular, 120 x 130 x 60 mm</li> <li>Q240L280 rectangular, 238 x 278 x 86 mm</li> <li>Q280L640 rectangular, 640 x 280 x 105 mm</li> <li>Q175L200 rectangular, 175 x 200 x 60 mm</li> </ul>		<ul style="list-style-type: none"> <li><b>Connector</b></li> <li>0,15-RS4.47T pigtail (150 mm) with male connector M12</li> <li>H1147 connector M12 x 1</li> <li>H1147L connector M12 x 1, lateral</li> <li>V1147 connector M8</li> </ul>			

S	S-Number	-	Ex	Approvals
	<ul style="list-style-type: none"> <li><b>S-Number</b></li> <li>S1126 optimized for different data carriers</li> </ul>		<ul style="list-style-type: none"> <li><b>Approvals</b></li> <li>Ex approval for Ex-Area</li> </ul>	



Type code – example

**T** **W** ... - **Q51** - **M** - **HT** - **B128** - **Ex**

Type code – explanation

<b>T</b>	<b>W</b>	...	Data carrier	-	<b>Q51</b>	Housing	-	<b>M</b>	On metal	-
			<ul style="list-style-type: none"> <li>Working frequency                             <ul style="list-style-type: none"> <li>blank 13.56 MHz</li> <li>125 125 KHz</li> <li>865-868 865...868 MHz</li> <li>865-928 865...928 MHz</li> <li>860-960 860...960 MHz</li> <li>902-928 902...928 MHz</li> </ul> </li> <li>Data carrier, memory access                             <ul style="list-style-type: none"> <li>W read/write</li> <li>R read only</li> </ul> </li> <li>TURCK RFID-System BL ident®</li> </ul>		<ul style="list-style-type: none"> <li>Housing                             <ul style="list-style-type: none"> <li>R... round &amp; diameter</li> <li>I... inlay &amp; dimensions</li> <li>L... label &amp; dimensions</li> <li>BD10x1.5-19 screw housing, plastic, M10 x 1.5, wrench size 19 mm</li> <li>BS10x1.5-19 screw housing, metal/ plastic, M10 x 1.5, wrench size 19 mm</li> <li>BV10x1.5-19 screw housing, stainless steel/ plastic, M10 x 1.5, wrench size 19 mm</li> <li>QxLy rectangular: x - width, y - length</li> <li>Q51 quadratic, lateral length: 51 mm</li> </ul> </li> </ul>		<ul style="list-style-type: none"> <li>On metal                             <ul style="list-style-type: none"> <li>M for direct mounting on metal</li> <li>MF for direct mounting on metal, foil shielded</li> </ul> </li> </ul>			

<b>HT</b>	High temperature	-	<b>B128</b>	Memory capacity total	-	<b>Ex</b>	Approvals
	<ul style="list-style-type: none"> <li>High temperature                             <ul style="list-style-type: none"> <li>HT High temperature</li> </ul> </li> </ul>		<ul style="list-style-type: none"> <li>Memory capacity total                             <ul style="list-style-type: none"> <li>B44 44 Byte</li> <li>B64 64 Byte</li> <li>B110 110 Byte</li> <li>B112 112 Byte</li> <li>B128 128 Byte</li> <li>B138 138 Byte</li> <li>K2 2 kByte</li> <li>K8 8 kByte</li> </ul> </li> </ul>		<ul style="list-style-type: none"> <li>Approvals                             <ul style="list-style-type: none"> <li>Ex Approval for Ex-Area</li> </ul> </li> </ul>		

Read/write heads and data carriers – HF

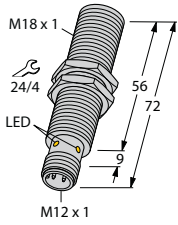
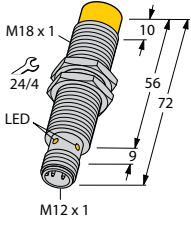
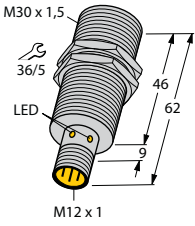
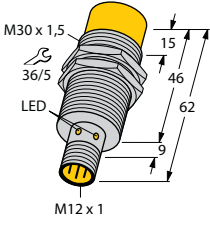
	Operating frequency [MHz]	Quality active face	Mounting conditions	Housing quality	Housing length [mm]	Protection class
	13.56	PA	flush	CuZn	72	IP67
	13.56	LCP	flush	VA	72	IP68 / IP69K
	13.56	LCP	flush	VA	72	IP68 / IP69K
	13.56	PA	non-flush	CuZn	72	IP67
	13.56	LCP	non-flush	VA	72	IP68 / IP69K
	13.56	LCP	non-flush	VA	72	IP68 / IP69K
	13.56	PA	flush	CuZn	62	IP67
	13.56	LCP	flush	VA	62	IP68 / IP69K
	13.56	LCP	flush	VA	62	IP68 / IP69K
	13.56	PA	non-flush	CuZn	62	IP67
	13.56	LCP	non-flush	VA	62	IP68 / IP69K
	13.56	LCP	non-flush	VA	62	IP68 / IP69K



	Ambient temperature [°C]	Remark to product	Approval features	Ident no.	Type
	-25...+70	–	–	7030001	<b>TB-M18-H1147</b>
	-25...+70	Wash-Down (IP69K)	–	7030224	<b>TB-EM18WD-H1147</b>
	-25...+70	ATEX	<ul style="list-style-type: none"> <li>▪ ATEX category II 3 G, Ex-zone 2</li> <li>▪ ATEX category II 3 D, Ex-zone 22</li> </ul>	7030381	<b>TB-EM18WD-H1147-EX</b>
	-25...+70	–	–	7030002	<b>TN-M18-H1147</b>
	-25...+70	Wash-Down (IP69K)	–	7030223	<b>TN-EM18WD-H1147</b>
	-25...+70	ATEX	<ul style="list-style-type: none"> <li>▪ ATEX category II 3 G, Ex-zone 2</li> <li>▪ ATEX category II 3 D, Ex-zone 22</li> </ul>	7030382	<b>TN-EM18WD-H1147-EX</b>
	-25...+70	–	–	7030003	<b>TB-M30-H1147</b>
	-25...+70	Wash-Down (IP69K)	–	7030221	<b>TB-EM30WD-H1147</b>
	-25...+70	ATEX	<ul style="list-style-type: none"> <li>▪ ATEX category II 3 G, Ex-zone 2</li> <li>▪ ATEX category II 3 D, Ex-zone 22</li> </ul>	7030385	<b>TB-EM30WD-H1147-EX</b>
	-25...+70	–	–	7030004	<b>TN-M30-H1147</b>
	-25...+70	Wash-Down (IP69K)	–	7030222	<b>TN-EM30WD-H1147</b>
	-25...+70	ATEX	<ul style="list-style-type: none"> <li>▪ ATEX category II 3 G, Ex-zone 2</li> <li>▪ ATEX category II 3 D, Ex-zone 22</li> </ul>	7030386	<b>TN-EM30WD-H1147-EX</b>

	Operating frequency [MHz]	Quality active face	Mounting conditions	Housing quality	Housing length [mm]	Protection class
	13.56	PBT	non-flush	PBT	52	IP67
	13.56	PA	non-flush	PBT	65	IP67
	13.56	–	non-flush	–	190	IP67
	13.56	–	non-flush	–	190	IP67

	Ambient temperature [°C]	Remark to product	Approval features	Ident no.	Type
	-25...+70	Flat design	–	7030235	TN-Q14-0.15-RS4.47T
	-25...+70	–	–	7030006	TN-CK40-H1147
	-25...+70	Flexible use	–	7030236	HT-IDENT-H1147
	-25...+70	Flexible use	–	7030238	HT-IDENT-H1187

	Operating frequency [MHz]	Quality active face	Mounting conditions	Housing quality	Housing length [mm]	Protection class	
	13.56	–	non-flush	PA	68	IP68 / IP69K	
	13.56	PBT	non-flush	PBT	92	IP67	
	13.56	PBT	non-flush	PBT	92	IP67	
	13.56	PBT	non-flush	PBT	92	IP67	
	13.56	PBT	non-flush	PBT	92	IP67	
	13.56	ABS	non-flush	POM	180	IP67	
	13.56	–	non-flush	PBT	400	IP67	
		13.56	–	non-flush	PBT	400	IP67

	Ambient temperature [°C]	Remark to product	Approval features	Ident no.	Type
	-25...+70	Wash-Down (IP69K), super long ranges	–	7030424	TNSLR-Q42TWD-H1147
	-25...+70	–	–	7030007	TN-Q80-H1147
	-25...+70	ATEX	<ul style="list-style-type: none"> <li>▪ ATEX category II 3 G, Ex-zone 2</li> <li>▪ ATEX category II 3 D, Ex-zone 22</li> </ul>	7030302	TN-Q80-H1147-EX
	-25...+70	–	–	7030230	TNLR-Q80-H1147
	-25...+70	ATEX	<ul style="list-style-type: none"> <li>▪ ATEX category II 3 G, Ex-zone 2</li> <li>▪ ATEX category II 3 D, Ex-zone 22</li> </ul>	7030303	TNLR-Q80-H1147-EX
	-25...+70	–	–	7030008	TN-S32XL-H1147
	-25...+70	For roller conveyors (vertical or horizontal orientation)	–	7030204	TNLR-Q80L400-H1147
	-25...+70	For roller conveyors (vertical or horizontal orientation)	–	7030234	TNLR-Q80L400-H1147L

	Operating frequency	Quality active face	Mounting conditions	Housing quality	Housing length	Protection class
	[MHz]				[mm]	
	13.56	–	non-flush	PBT	370	IP67

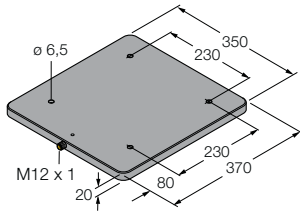

	Ambient temperature [°C]	Remark to product	Approval features	Ident no.	Type
	-25...+70	Super long ranges	-	7030454	TNSLR-Q350-H1147

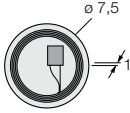
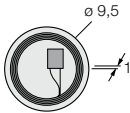
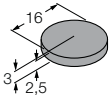
	Operating frequency [MHz]	Quality active face	Housing quality	Housing length [mm]	Memory [Byte]	Number of read operations	Number of write operations	Typical read time [ms/Byte]	Typical write time [ms/Byte]	Protection class	
	13.56	Epoxy	Epoxy	–	128	unlimited	10 <sup>5</sup>	2	3	IP68	
	13.56	Epoxy	Epoxy	–	128	unlimited	10 <sup>5</sup>	2	3	IP68	
	13.56	PA	PA	–	128	unlimited	10 <sup>5</sup>	2	3	IP69K	
	13.56	PA	PA	–	2048	unlimited	10 <sup>10</sup>	0.5	0.5	IP69K	
	13.56	PA	PA	–	128	unlimited	10 <sup>5</sup>	2	3	IP69K	
	13.56	PA	PA	–	128	unlimited	10 <sup>5</sup>	2	3	IP69K	
	13.56	PA	PA	–	2048	unlimited	10 <sup>10</sup>	0.5	0.5	IP69K	
	13.56	PA	PA	–	2048	unlimited	10 <sup>10</sup>	0.5	0.5	IP69K	

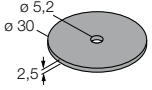
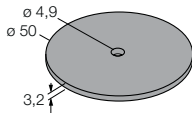
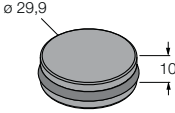
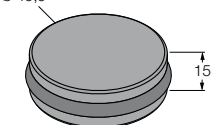

	Ambient temperature [°C]	Extended temperature range [°C]	Storage temperature [°C]	Remark to product	Approval features	Ident. no.	Type
	-25...+85	–	-40...85	Small design	–	7030231	<b>TW-R7.5-B128</b>
	-25...+85	–	-40...85	Small design	–	7030252	<b>TW-R9.5-B128</b>
	-25...+85	160 (1x35 h) 220 (1x30 s)	-25...120	extended storage temperature range	–	6900501	<b>TW-R16-B128</b>
	-25...+85	160 (1x35 h) 220 (1x30 s)	-25...120	extended storage temperature range	–	7030410	<b>TW-R16-K2</b>
	-25...+85	140 (1x100 h)	-45...85	–	–	6900502	<b>TW-R20-B128</b>
	-25...+85	140 (1x100 h)	-45...85	ATEX	<ul style="list-style-type: none"> <li>▪ ATEX category II 2 G, Ex-zone 1</li> <li>▪ ATEX category II 2 D, Ex-zone 21</li> </ul>	7030242	<b>TW-R20-B128-EX</b>
	-25...+85	140 (1x100 h)	-45...85	–	–	6900505	<b>TW-R20-K2</b>
	-25...+85	140 (1x100 h)	-45...85	ATEX	<ul style="list-style-type: none"> <li>▪ ATEX category II 2 G, Ex-zone 1</li> <li>▪ ATEX category II 2 D, Ex-zone 21</li> </ul>	7030245	<b>TW-R20-K2-EX</b>

	Operating frequency	Quality active face	Housing quality	Housing length	Memory	Number of read operations	Number of write operations	Typical read time	Typical write time	Protection class		
	[MHz]			[mm]	[Byte]			[ms/Byte]	[ms/Byte]			
	13.56	PA	PA	–	128	unlimited	10 <sup>5</sup>	2	3	IP69K		
	13.56	PA	PA	–	128	unlimited	10 <sup>5</sup>	2	3	IP69K		
	13.56	PA	PA	–	2048	unlimited	10 <sup>10</sup>	0.5	0.5	IP69K		
	13.56	PA	PA	–	2048	unlimited	10 <sup>10</sup>	0.5	0.5	IP69K		
	13.56	PA	PA	–	128	unlimited	10 <sup>5</sup>	2	3	IP69K		
	13.56	PA	PA	–	128	unlimited	10 <sup>5</sup>	2	3	IP69K		
	13.56	PA	PA	–	2048	unlimited	10 <sup>10</sup>	0.5	0.5	IP69K		
	13.56	PA	PA	–	2048	unlimited	10 <sup>10</sup>	0.5	0.5	IP69K		
	13.56	PA	PA	–	8192	unlimited	10 <sup>10</sup>	0.5	0.5	IP69K		
	13.56	PET	PET	–	128	unlimited	10 <sup>5</sup>	2	3	IP68		
	13.56	PET	PET	–	2048	unlimited	10 <sup>10</sup>	0.5	0.5	IP68		
	13.56	PET	PET	–	128	unlimited	10 <sup>5</sup>	2	3	IP68		
	13.56	PET	PET	–	2048	unlimited	10 <sup>10</sup>	0.5	0.5	IP68		

	Ambient temperature [°C]	Extended temperature range [°C]	Storage temperature [°C]	Remark to product	Approval features	Ident. no.	Type
	-25...+85	140 (1x100 h)	-45...85	–	–	6900503	<b>TW-R30-B128</b>
	-25...+85	140 (1x100 h)	-45...85	ATEX	<ul style="list-style-type: none"> <li>▪ ATEX category II 2 G, Ex-zone 1</li> <li>▪ ATEX category II 2 D, Ex-zone 21</li> </ul>	7030243	<b>TW-R30-B128-EX</b>
	-25...+85	140 (1x100 h)	-45...85	–	–	6900506	<b>TW-R30-K2</b>
	-25...+85	140 (1x100 h)	-45...85	ATEX	<ul style="list-style-type: none"> <li>▪ ATEX category II 2 G, Ex-zone 1</li> <li>▪ ATEX category II 2 D, Ex-zone 21</li> </ul>	7030246	<b>TW-R30-K2-EX</b>
	-25...+85	140 (1x100 h)	-45...85	–	–	6900504	<b>TW-R50-B128</b>
	-25...+85	140 (1x100 h)	-45...85	ATEX	<ul style="list-style-type: none"> <li>▪ ATEX category II 2 G, Ex-zone 1</li> <li>▪ ATEX category II 2 D, Ex-zone 21</li> </ul>	7030244	<b>TW-R50-B128-EX</b>
	-25...+85	140 (1x100 h)	-45...85	–	–	6900507	<b>TW-R50-K2</b>
	-25...+85	140 (1x100 h)	-45...85	ATEX	<ul style="list-style-type: none"> <li>▪ ATEX category II 2 G, Ex-zone 1</li> <li>▪ ATEX category II 2 D, Ex-zone 21</li> </ul>	7030247	<b>TW-R50-K2-EX</b>
	-25...+85	140 (1x100 h)	-45...85	–	–	7030233	<b>TW-R50-K8</b>
	-25...+85	140 (1x100 h)	-45...85	for mounting in/on metal	–	7030210	<b>TW-R30-M-B128</b>
	-25...+85	140 (1x100 h)	-45...85	for mounting in/on metal	–	7030206	<b>TW-R30-M-K2</b>
	-25...+85	140 (1x100 h)	-45...85	for mounting in/on metal	–	7030209	<b>TW-R50-M-B128</b>
	-25...+85	140 (1x100 h)	-45...85	for mounting in/on metal	–	7030229	<b>TW-R50-M-K2</b>

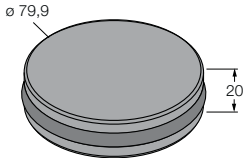
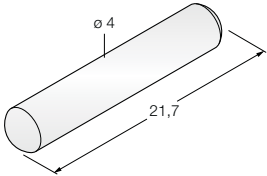
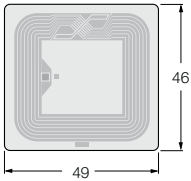
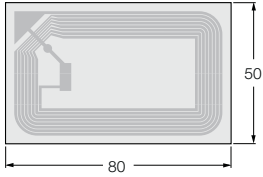
	Operating frequency	Quality active face	Housing quality	Housing length	Memory	Number of read operations	Number of write operations	Typical read time	Typical write time	Protection class	
	[MHz]			[mm]	[Byte]			[ms/Byte]	[ms/Byte]		
	13.56	PET	PET	–	128	unlimited	10 <sup>5</sup>	2	3	IP68	
	13.56	PET	PET	–	2048	unlimited	10 <sup>10</sup>	0.5	0.5	IP68	
	13.56	glass	–	–	128	unlimited	10 <sup>5</sup>	2	3	IP68	
	13.56	PP	PET	–	128	unlimited	10 <sup>5</sup>	2	3	IP40	
	13.56	Paper	PET	–	128	unlimited	10 <sup>5</sup>	2	3	IP40	

Ambient temperature [°C]	Extended temperature range [°C]	Storage temperature [°C]	Remark to product	Approval features	Ident. no.	Type
-25...+85	140 (1x100 h)	-45...85	for mounting in/on metal	–	7030207	<b>TW-R80-M-B128</b>
-25...+85	140 (1x100 h)	-45...85	for mounting in/on metal	–	7030205	<b>TW-R80-M-K2</b>
-25...+85	–	-40...140	Glass data-carrier, for use in autoclaves	–	7030237	<b>TW-R4-22-B128</b>
-20...+70	–	-20...70	Smart-Label, self-adhesive	–	7030390	<b>TW-L49-46-F-B128</b>
-20...+70	–	-20...70	Smart-Label, self-adhesive	–	7030389	<b>TW-L80-50-P-B128</b>

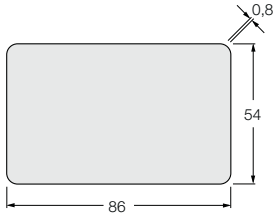
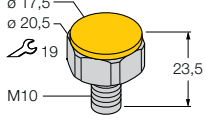
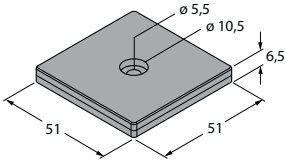
	Operating frequency	Quality active face	Housing quality	Housing length	Memory	Number of read operations	Number of write operations	Typical read time	Typical write time	Protection class	
	[MHz]			[mm]	[Byte]			[ms/Byte]	[ms/Byte]		
	13.56	PC	PC	–	128	unlimited	10 <sup>5</sup>	2	3	IP67	
	13.56	POM	POM	–	128	unlimited	10 <sup>5</sup>	2	3	IP68	
	13.56	POM	POM	–	2048	unlimited	10 <sup>10</sup>	0.5	0.5	IP68	
	13.56	LCP	S235JRG2/ LCP	–	128	unlimited	10 <sup>5</sup>	2	3	IP68	
	13.56	LCP	S235JRG2/ LCP	–	2048	unlimited	10 <sup>10</sup>	0.5	0.5	IP68	
	13.56	PA	1.4401/ LCP	–	128	unlimited	10 <sup>5</sup>	2	3	IP68	
	13.56	PA	1.4401/ LCP	–	2048	unlimited	10 <sup>10</sup>	0.5	0.5	IP68	
	13.56	PPS	–	51	128	unlimited	10 <sup>5</sup>	2	3	IP68	

Ambient temperature [°C]	Extended temperature range [°C]	Storage temperature [°C]	Remark to product	Approval features	Ident. no.	Type
-25...+50	–	-25...50	credit-card size	–	6900479	<b>TW-L86-54-C-B128</b>
-25...+85	–	-45...85	data carrier, can be screwed in metal	–	6901384	<b>TW-BD10X1.5-19-B128</b>
-25...+85	–	-45...85	data carrier, can be screwed in metal	–	6901381	<b>TW-BD10X1.5-19-K2</b>
-25...+85	–	-45...85	data carrier, can be screwed in metal	–	6901383	<b>TW-BS10X1.5-19-B128</b>
-25...+85	–	-45...85	data carrier, can be screwed in metal	–	6901380	<b>TW-BS10X1.5-19-K2</b>
-25...+85	–	-45...85	data carrier, can be screwed in metal	–	6901385	<b>TW-BV10X1.5-19-B128</b>
-25...+85	–	-45...85	data carrier, can be screwed in metal	–	6901382	<b>TW-BV10X1.5-19-K2</b>
-25...+85	200 (60 min.) 220 (45 min.)	-55...185	High- temperature, for use in autoclaves	–	7030364	<b>TW-Q51-HT-B128</b>

Read/write heads and data carriers – HF

Data carriers	Read/write heads												
		TB-M18-H1147	TB-EM18WD-H1147	TN-M18-H1147	TN-EM18WD-H1147	TB-EM18WD-H1147-EX	TN-EM18WD-H1147-EX	TB-M30-H1147	TB-EM30WD-H1147	TN-M30-H1147	TN-EM30WD-H1147	TB-EM30WD-H1147-EX	TN-EM30WD-H1147-EX
TW-R7.5-B128	E	8	8	8	8			8	8	10	10		
	M	14	14	16	16			18	18	30	30		
	L	16	16	20	20			20	20	28	28		
TW-R9.5-B128	E	9	9	9	9			9	9	11	11		
	M	15	15	18	18			20	20	33	33		
	L	18	18	22	22			22	22	31	31		
TW-R16-B128	E	10	10	12	12			12	12	20	20		
	M	17	17	23	23			23	23	38	38		
	L	14	14	26	26			20	20	44	44		
TW-R16-K2	E	10	10	12	12			12	12	20	20		
	M	17	17	23	23			23	23	38	38		
	L	14	14	26	26			20	20	44	44		
TW-R20-B128	E	8	8	10	10			15	15	22	22		
	M	15	15	22	22			27	27	40	40		
	L	12	12	26	26			20	20	34	34		
TW-R30-B128	E	8	8	10	10			13	13	22	22		
	M	17	17	25	25			30	30	43	43		
	L	22	22	34	34			32	32	56	56		
TW-R20-K2	E	5	5	12	12			15	15	17	17		
	M	12	12	20	20			22	22	31	31		
	L	16	16	24	24			20	20	32	32		
TW-R30-K2	E	6	6	16	16			15	15	23	23		
	M	14	14	31	31			27	27	42	42		
	L	18	18	32	32			32	32	50	50		
TW-L49-46-F-B128	E	12	12	21	21			21	21	25	25		
	M	25	25	38	38			35	35	54	54		
	L	29	29	37	37			37	37	57	57		
TW-L80-50-P-B128	E	12	12	17	17			17	17	25	25		
	M	20	20	34	34			36	36	55	55		
	L	54	54	61	61			64	64	71	71		
TW-BD10x1.5-19-K2	E	6	6										
	M	14	14										
	L	16	16										
TW-R30-M-B128	E	8	8	6	6								
	M	12	12	14	14								
	L	16	16	16	16								
TW-R50-M-B128	E	8	8	10	10			15	15	20	20		
	M	18	18	22	22			27	27	36	36		
	L	22	22	22	22			22	22	34	34		
TW-R30-M-K2	E	7	7	6	6								
	M	10	10	13	13								
	L	18	18	10	10								
TW-R50-M-K2	E	7	7	10	10			10	10	15	15		
	M	15	15	22	22			21	21	30	30		
	L	24	24	32	32			26	26	32	32		
TW-R4-22-B128	E	3	3	5	5			5	5	10	10		
	M	9	9	13	13			16	16	28	28		
	L	12	12	20	20			22	22	38	38		
TW-L86-54-C-B128	E	10	10	15	15			20	20	30	30		
	M	21	21	39	39			45	45	77	77		
	L	70	70	74	74			80	80	92	92		

read/write range [mm]: E = recommended; M = maximum; L = Length of transmission zone at recommended range

**NOTE:**

The maximum read/write range (M) and length of the transmission zone (L) are standard values measured under laboratory conditions.



	TN-CK40-H1147	HT-IDENT-H1147	HT-IDENT-H1187	TN-Q14-0.15-RS4.4TT	TN-Q80-H1147	TN-Q80-H1147-EX	TNLR-Q80-H1147	TNLR-Q80-H1147-EX	TNLR-Q80L400-H1147 (längs)	TNLR-Q80L400-H1147 (quer)	TNLR-Q80L400-H1147L (längs)	TNLR-Q80L400-H1147L (quer)	TNLR-Q350-H1147	TN-S32XL-H1147	TNSLR-Q42TWD-H1147	TNSLR-Q350-H1147
	13 30 42	13 30 42	13 30 42	10 30 28	10 34 62		20 41 60								20 41 60	
	14 33 46	14 33 46	14 33 46	11 33 31	11 37 68		22 45 66								22 45 66	
	28 50 54	28 50 54	28 50 54	20 38 44	20 52 60		50 85 90		30 95 410	50 95 74	50 95 74	30 95 410	60 203 360	20 67 125	50 85 90	72 244 432
	28 50 54	28 50 54	28 50 54	20 38 44	20 52 60		50 85 90		30 95 410	50 95 74	50 95 74	30 95 410	60 203 360	20 67 125	50 85 90	72 244 432
	30 50 50	30 50 50	30 50 50	22 40 34	35 65 72		50 88 92		40 102 404	60 102 86	60 102 86	40 102 404	100 215 350	36 72 103	50 88 92	120 258 420
	30 53 62	30 53 62	30 53 62	22 43 56	35 72 80		60 115 116		60 152 434	90 152 132	90 152 132	60 152 434	80 218 350	30 80 120	60 115 116	96 262 420
	22 40 36	22 40 36	22 40 36	17 31 32	25 52 70		40 75 84		30 64 390	15 64 70	15 64 70	30 64 390	80 155 310	20 60 130	40 75 84	96 186 372
	30 55 56	30 55 56	30 55 56	23 42 50	35 67 80		60 98 104		50 122 416	70 122 100	70 122 100	50 122 416	100 250 380	30 82 132	60 98 104	120 300 456
	42 76 80	42 76 80	42 76 80	25 54 57	51 97 98		76 131 136		68 176 394	74 175 149	74 176 149	68 176 394	170 353 389	68 119 148	76 131 136	204 424 467
	42 81 93	42 81 93	42 81 93	25 55 71	55 108 115		76 142 144			136 229 204	136 229 204		204 425 440	68 136 161	76 142 144	245 510 528
	23 46 48	23 46 48	23 46 48	20 36 34	25 53 66		35 58 64								35 58 64	
	15 37 46	15 37 46	15 37 46	15 30 32	15 41 58		30 58 76								30 58 76	
	20 40 50	20 40 50	20 40 50	10 20 32	20 48 68		40 73 86		20 80 368	40 78 68	40 78 68	20 80 368	50 197 328	10 42 118	40 73 86	60 236 394
	60 115 132	60 115 132	60 115 132	20 65 98	70 146 158		120 215 214		120 360 484	200 345 306	200 345 306	120 360 484	360 662 660	90 180 206	120 215 214	432 794 792

Read/write heads and data carriers – HF

Data carriers:  = PHILIPS I-Code SLI (SL2)  = Fujitsu FRAM

Data carriers	Read/write heads	TB-M18-H1147	TB-EM18WD-H1147	TN-M18-H1147	TN-EM18WD-H1147	TB-EM18WD-H1147-EX	TN-EM18WD-H1147-EX	TB-M30-H1147	TB-EM30WD-H1147	TN-M30-H1147	TN-EM30WD-H1147	TB-EM30WD-H1147-EX	TN-EM30WD-H1147-EX
TW-R50-B128	E			20	20			20	20	40	40		
	M			41	41			43	43	72	72		
	L			70	70			46	46	76	76		
TW-Q51-HT-B128	E			22	22			22	22	44	44		
	M			45	45			47	47	79	79		
	L			77	77			51	51	84	84		
TW-R50-K2	E			12	12			15	15	30	30		
	M			30	30			33	33	58	58		
	L			60	60			36	36	76	76		
TW-BD10X1.5-19-K2	E			8	8			10	10				
	M			17	17			20	20				
	L			22	22			22	22				
TW-R20-B128-EX	E					8	8					15	22
	M					15	15					27	40
	L					12	12					20	34
TW-R20-K2-EX	E					5	5					15	17
	M					12	12					22	31
	L					16	16					20	32
TW-R30-B128-EX	E					8	8					13	22
	M					17	17					30	43
	L					22	22					32	56
TW-R30-K2-EX	E					6	6					15	23
	M					14	14					27	42
	L					18	18					32	50
TW-R50-B128-EX	E						20					20	40
	M						41					43	72
	L						70					46	76
TW-R50-K2-EX	E						12					15	30
	M						30					33	58
	L						60					36	76
TW-B510X1.5-19-K2	E							4	4				
	M							12	12				
	L							17	17				
TW-B510X1.5-19-B128	E									5	5		
	M									15	15		
	L									21	21		
TW-BD10X1.5-19-B128	E									14	14		
	M									29	29		
	L									30	30		
TW-R80-M-B128	E												
	M												
	L												
TW-R80-M-K2	E												
	M												
	L												
TW-L80-50-F-B128	E												
	M												
	L												

read/write range [mm]: E = recommended; M = maximum; L = Length of transmission zone at recommended range

**NOTE :**

The maximum read/write range (M) and length of the transmission zone (L) are standard values measured under laboratory conditions.

	TN-CK40-H1147	HT-IDENT-H1147	HT-IDENT-H1187	TN-Q14-0.15-RS4.47T	TN-Q80-H1147	TN-Q80-H1147-EX	TNLR-Q80-H1147	TNLR-Q80-H1147-EX	TNLR-Q80L400-H1147 (längs)	TNLR-Q80L400-H1147 (quer)	TNLR-Q80L400-H1147L (längs)	TNLR-Q80L400-H1147L (quer)	TNLR-Q350-H1147	TN-S32XL-H1147	TNSLR-Q42TWD-H1147	TNSLR-Q350-H1147
	45	45	45	40	65		80		100	150	150	100	200	80	80	240
	85	85	85	72	118		165		256	256	256	256	462	150	165	554
	96	96	96	76	120		168		484	230	230	484	530	160	168	636
	50	50	50	44	72		88		110	165	165	110	220	88	88	264
	94	94	94	79	130		182		282	282	282	282	508	165	165	609
	106	106	106	84	132		185		532	253	253	532	583	176	176	700
	38	38	38	30	50		90		90	120	120	90	200	60	90	240
	81	81	81	58	100		144		216	216	216	216	405	128	144	486
	82	82	82	76	110		150		466	190	190	466	480	160	150	576
	20	20	20													
	39	39	39													
	44	44	44													
						35		50								
						65		88								
						72		92								
						25		40								
						52		75								
						70		84								
						35		60								
						72		115								
						80		116								
						35		60								
						67		98								
						80		104								
								80								
								165								
								168								
						50		90								
						100		144								
						110		150								
	6	6	6													
	18	18	18													
	34	34	34													
				5												
				15												
				21												
				14												
				29												
				30												
	25	25	25		40		50		30	40	40	30				
	53	53	53		76		90		77	77	77	77				
	68	68	68		76		90		398	56	56	398				
	15	15	15		20		35		30	30	30	30				
	47	47	47		55		78		68	77	77	68				
	54	54	54		64		80		390	64	64	390				
									85			85				
									229			229				
									414			414				

Data carriers:  = PHILIPS I-Code SLI (SL2)  = Fujitsu FRAM



# Read/write heads and data carriers – UHF



Scan the QR code to access our products on the internet

## BL ident® read/write heads and data carriers – UHF

High-speed transmission of data across long ranges are the core features of RFID systems transmitting within a frequency band of 865...928 MHz (UHF). Therefore UHF became standard for applications demanding greater distances between read/write head and data carrier.

The international radio transmission protocol ISO 18000-6 C, based on EPCglobal Class 1 Gen 2, guarantees moreover investment security and flexibility regarding the combination of read/write heads and data carriers for UHF applications.

The achievable ranges depend on the individual application conditions and the combination of read/write heads and data carriers used. Radio ranges of several meters are possible with the *BL ident*®

system. This means high operational safety for automated processes where data carriers are constantly in motion, and it also provides high flexibility for manually executed identification tasks. The *BL ident*® data carriers are entirely maintenance-free, thanks to power supplied passively via the read/write head's electromagnetic field.

Bulk reading is also possible: *BL ident*® systems using UHF frequencies are capable of reading many data carriers of the same type simultaneously automatically, once they are in the air-interface of the read/write head. This saves you valuable processing time with each identification event.

# Type code – HF and UHF

## Type code – example

T	N	LR	...	-	Q80	-	H1147	-	S	-	Ex
---	---	----	-----	---	-----	---	-------	---	---	---	----

## Type code – explanation

T	N	LR	...	Read/write head	-	Q80	Housing	-	H1147	Connector type	/			
				<b>Working frequency</b> blank 13.56 MHz 865 865...868 MHz 902 902...928 MHz 840/ 840.5...844.5 MHz & 920 920.5...924.5 MHz 902/ 902...907 MHz & 915 915...928 MHz 917 917...920.8 MHz  <b>Special range</b> ER extended range LR long range SLR super long range  <b>Read/write heads, mounting condition</b> B flush mountable N non-flush mountable  <b>TURCK RFID-System</b> BL ident®					<b>Housing</b> M18 thread M18 M30 thread M30 Q14 rectangular 55.5 x 30 x 14 mm CK40 rectangular 40 x 40 x 65 mm, variable orientation of active face  Q80 rectangular, 114 x 80 x 40 mm S32XL ring shaped, 180 x 120 x 32 mm Q350 rectangular, 370 x 350 x 20 mm Q80L400 rectangular, 400 x 80 x 25 mm Q120L130 rectangular, 120 x 130 x 60 mm Q240L280 rectangular, 238 x 278 x 86 mm Q280L640 rectangular, 640 x 280 x 105 mm Q175L200 rectangular, 175 x 200 x 60 mm					<b>Connector</b> 0,15-RS4.47T pigtail (150 mm) with male connector M12 H1147 connector M12 x 1 H1147L connector M12 x 1, lateral V1147 connector M8

S	S-Number	-	Ex	Approvals
---	----------	---	----	-----------

**S-Number**  
 S1126 optimized for different data carriers

**Approvals**  
 Ex approval for Ex-Area



Type code – example

**T** **W** ... - **Q51** - **M** - **HT** - **B128** - **Ex**

Type code – explanation

**T** **W** ... **Data carrier** - **Q51** **Housing** - **M** **On metal** -

<p><b>Working frequency</b></p> <p><b>blank</b> 13.56 MHz</p> <p><b>125</b> 125 KHz</p> <p><b>865-868</b> 865...868 MHz</p> <p><b>865-928</b> 865...928 MHz</p> <p><b>860-960</b> 860...960 MHz</p> <p><b>902-928</b> 902...928 MHz</p> <p><b>Data carrier, memory access</b></p> <p><b>W</b> read/write</p> <p><b>R</b> read only</p> <p><b>TURCK RFID-System</b> <i>BL ident®</i></p>	<p><b>Housing</b></p> <p><b>R...</b> round &amp; diameter</p> <p><b>I...</b> inlay &amp; dimensions</p> <p><b>L...</b> label &amp; dimensions</p> <p><b>BD10x1.5-19</b> screw housing, plastic, M10 x 1.5, wrench size 19 mm</p> <p><b>BS10x1.5-19</b> screw housing, metal/ plastic, M10 x 1.5, wrench size 19 mm</p> <p><b>BV10x1.5-19</b> screw housing, stainless steel/ plastic, M10 x 1.5, wrench size 19 mm</p> <p><b>QxLy</b> rectangular: x - width, y - length</p> <p><b>Q51</b> quadratic, lateral length: 51 mm</p>	<p><b>On metal</b></p> <p><b>M</b> for direct mounting on metal</p> <p><b>MF</b> for direct mounting on metal, foil shielded</p>
---	---	--

**HT** **High temperature** - **B128** **Memory capacity total** - **Ex** **Approvals**

<p><b>High temperature</b></p> <p><b>HT</b> High temperature</p>	<p><b>Memory capacity total</b></p> <p><b>B44</b> 44 Byte</p> <p><b>B64</b> 64 Byte</p> <p><b>B110</b> 110 Byte</p> <p><b>B112</b> 112 Byte</p> <p><b>B128</b> 128 Byte</p> <p><b>B138</b> 138 Byte</p> <p><b>K2</b> 2 kByte</p> <p><b>K8</b> 8 kByte</p>	<p><b>Approvals</b></p> <p><b>Ex</b> Approval for Ex-Area</p>
--	---	---

Read/write heads and data carriers – UHF

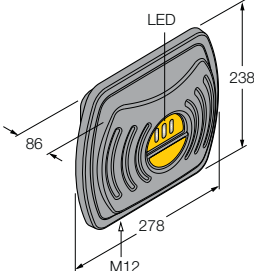
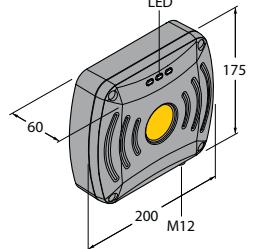
	Operating frequency [MHz]	Quality active face	Mounting conditions	Housing quality
	865...868	ABS	non-flush	AL
	902...928	ABS	non-flush	AL
	920...925	ABS	non-flush	AL
	902...907.5 + 915...928	ABS	non-flush	AL
	865...868	ABS	non-flush	AL
	902...928	ABS	non-flush	AL
	920...925	ABS	non-flush	AL
	917...920.8	ABS	non-flush	AL

Devices available from 10/2013. Technical change to alterations.

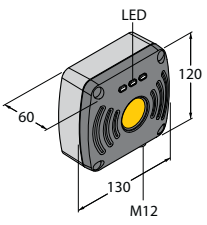
	865...868	ABS	non-flush	AL
	902...928	ABS	non-flush	AL
	920...925	ABS	non-flush	AL
	917...920.8	ABS	non-flush	AL



	Housing length [mm]	Protection class	Ambient temperature [°C]	Wiring diagram 3	Ident no.	Type
	278	IP65	-20...+50	w009	7030295	TN865-Q240L280-H1147
	278	IP65	-20...+50	w009	7030304	TN902-Q240L280-H1147
	278	IP65	-20...+50	w009	7030360	TN840/920-Q240L280-H1147
	278	IP65	-20...+50	w009	7030465	TN902/915-Q240L280-H1147
	200	IP67	-25...+50	w009	7030452	TN865-Q175L200-H1147
	200	IP67	-25...+50	w009	7030457	TN902-Q175L200-H1147
	200	IP67	-25...+50	w009	7030466	TN840/920-Q175L200-H1147
	200	IP67	-25...+50	w009	7030513	TN917-Q175L200-H1147

	130	IP67	-25...+50	w009	7030520	TN865-Q120L130-H1147
	130	IP67	-25...+50	w009	7030535	TN902-Q120L130-H1147
	130	IP67	-25...+50	w009	7030536	TN840/920-Q120L130-H1147
	130	IP67	-25...+50	w009	7030537	TN917-Q120L130-H1147

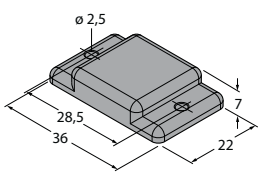
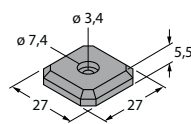
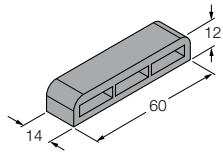
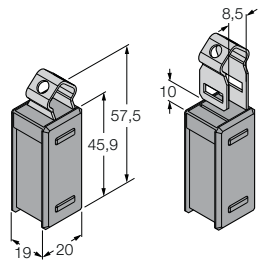
	Operating frequency [MHz]	Quality active face	Housing quality	Housing length [mm]	Memory [Byte]	Number of read operations	Number of write operations	Typical read time [ms/Byte]	Typical write time [ms/Byte]	Protection class	Ambient temperature [°C]
	865...868	TPE	-	36	112	unlimited	10 <sup>5</sup>	2	3	IP67	-40...+85
	902...928	-	PA	-	112	unlimited	10 <sup>5</sup>	2	3	IP68	-20...+80
	865...868	-	-	-	110	unlimited	10 <sup>4</sup>	2	3	IP67	-35...+85
	902...928	-	-	-	110	unlimited	10 <sup>4</sup>	2	3	IP67	-35...+85
	865...928	-	-	-	110	unlimited	10 <sup>4</sup>	2	3	IP67	-30...+70
											

	Extended temperature range [°C]	Storage temperature [°C]	Remark to product	Mechanische Features	Ident. no.	Type
	–	-40...200	High-temperature, for direct mounting on metal	▪ Only for direct mounting on metal	7030450	<b>TW865-868-Q22L36-M-HT-B112</b>
	–	-20...80	For direct mounting on metal	▪ Only for direct mounting on metal	7030374	<b>TW865-868-Q27-M-B112</b>
	–	-20...80	For direct mounting on metal	▪ Only for direct mounting on metal	7030406	<b>TW902-928-Q27-M-B112</b>
	–	-35...85	For direct mounting on metal and outdoor use	▪ For direct mounting on metal	7030376	<b>TW865-868-Q14L60-M-B110</b>
	–	-35...85	For direct mounting on metal and outdoor use	▪ For direct mounting on metal	7030408	<b>TW902-928-Q14L60-M-B110</b>
	–	-30...70	–	▪ Mounted with metal eyelet	7030375	<b>TW865-928-Q20L58-B110</b>

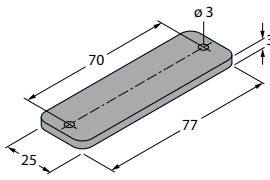
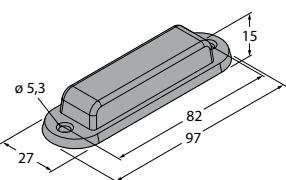
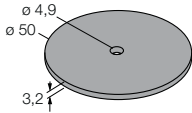
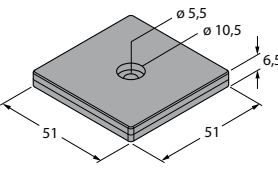
	Operating frequency [MHz]	Quality active face	Housing quality	Housing length [mm]	Memory [Byte]	Number of read operations	Number of write operations	Typical read time [ms/Byte]	Typical write time [ms/Byte]	Protection class	Ambient temperature [°C]
	860...960	TPE	TPE	77	112	unlimited	10 <sup>5</sup>	2	3	IP67	-40...+70
	860...960	–	Polycarbonate/ABS	97	112	unlimited	10 <sup>5</sup>	2	3	IP69K	-40...+80
	865...868	PA	PA	–	110	unlimited	10 <sup>4</sup>	2	3	IP69K	-20...+85
	902...928	PA	PA	–	110	unlimited	10 <sup>4</sup>	2	3	IP69K	-20...+85
	865...868	PPS	–	51	110	unlimited	10 <sup>4</sup>	2	3	IP68	-25...+85

	Extended temperature range [°C]	Storage temperature [°C]	Remark to product	Mechanische Features	Ident. no.	Type
	–	–40...70	–	▪ Flexible design, for mounting on curved or irregular surfaces	7030458	<b>TW860-960-Q25L77-B-B112</b>
	–	–40...80	For direct mounting on metal and outdoor use	▪ For direct mounting on metal	7030464	<b>TW860-960-Q27L97-M-B112</b>
	140 (1x100 h)	–40...90	–	–	7030257	<b>TW865-868-R50-B110</b>
	140 (1x100 h)	–40...90	–	–	7030404	<b>TW902-928-R50-B110</b>
	200 (60 min.) 220 (45 min.)	–55...185	High-temperature	–	7030447	<b>TW865-868-Q51-HT-B110</b>

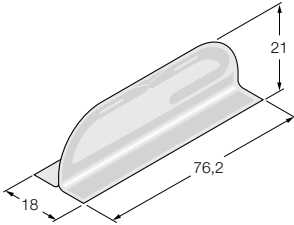
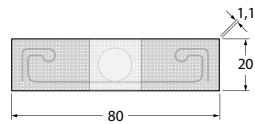
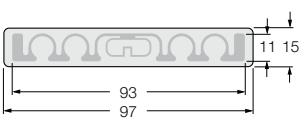
	Operating frequency [MHz]	Quality active face	Housing quality	Housing length [mm]	Memory [Byte]	Number of read operations	Number of write operations	Typical read time [ms/Byte]	Typical write time [ms/Byte]	Protection class	Ambient temperature [°C]
	865...928	PET	PET	–	110	unlimited	10 <sup>4</sup>	2	3	IP67	-35...+85
	865...868	–	–	–	44	unlimited	10 <sup>5</sup>	2	3	IP40	-20...+65
	860...960	PET	PET	97	44	unlimited	10 <sup>5</sup>	2	3	IP40	-10...+85

	Extended temperature range [°C]	Storage temperature [°C]	Remark to product	Mechanische Features	Ident. no.	Type
	–	-35...85	Smart-Label, self-adhesive	▪ For direct mounting on metal	7030380	<b>TW865-928-L76-18-21-F-M-B110</b>
	180 (up to 5 bar for 10 minutes)	–	Smart-Label, self-adhesive	–	7030484	<b>TW865-868-L80-20-T-B44</b>
	–	–	Smart-Label, self-adhesive	–	7030524	<b>TW860-960-L97-15-F-B44</b>

# General information

## Materials – Abbreviations and definitions

### ABS

ABS Acrylonitrile-Butadiene-Styrene  
Impact resistant, stiff

### AL

Al Aluminium  
Low specific weight, good resistance to oxidation

### CuZn-Ni

Nickel-plated brass

### EP

EP Epoxy resin  
Is a compound of polymers (Polyether) and a suitable hardener, forming a thermosetting plastic of high durability and chemical resistance.

### LCP

LCP Liquid Cristal Polymers, liquid cristal Copolyester  
High thermostability and resistance to chemicals, low thermal expansion, good chemical properties, flame retardant

### PA

PA (Polyamide)  
Wear-free, stiff, impact resistant, good thermostability

### PBT

PBT Polybutylene Terephthalate (thermoplastic polyester)  
Rigid, stiff, solid, tough (even at low temperatures), good resistance to chemicals, flame retardant, self-extinguishing and UV resistant

### PC

PC Polycarbonate  
transparent, highly resistant to impacts, very stiff, solid, tough, good thermostability, flame retardant, self-extinguishing

### PET

PET Polyethylene Terephthalate  
Highly formstable, rugged and stiff, highly wear-free

### POM

POM Polyoxymethylene  
Highly resistant to impacts, good mechanical stability, good resistant to chemicals

### PP

PP Polypropylene  
Excellent resistance to chemicals, even to acids, alkalis and solvents, high thermostability, high mechanical stability

### PPS

PPS Polyphenylene Sulfide  
Highly rugged and thermostable, high resistance against chemicals, flame-retardant.

### PTFE

PTFE Polytetrafluorethylene;  
Highly thermostable and chemical-resistant plastic

### PUR

PUR Polyurethane  
Elastic, wear-free, impact resistant, good resistance to oils, lubricants and solvents

### S235JR

S235JR unalloyed structural steel acc. to EN 10025  
Material no. 1.0038; former DIN 17100 St37-2

### TPE

TPE Thermoplastic Elastomer:  
Thermoplastic elastomers are plastics behaving similar to conventional elastomers at room temperature but deform under heat supply.

### TPU

TPU Thermoplastic Polyurethane (PUR) Elastomer:  
Highly impact resistant and formstable, resistant to many chemicals, thermostable, broad temperature range.



# Information

## **ULTEM (PEI)**

---

PEI Polyetherimide

Highly rugged, stiff and hard, high thermostability, operates in a broad temperature range, good resistance to high-energy radiation, flame retardant and self-extinguishing, transparent and UV resistant

## **V4A**

---

VA high-quality stainless steel

V4A denotes a certain type of steel and stands for the CrNiMo steels with the material grade numbers 1.4401 (AISI 316), 1.4571 (AISI 316Ti) and 1.4404 (AISI 316L)

## **VA**

---

VA high-quality stainless steel

Corrosion and acid-resistant steel, highly stable for higher demands – also suitable for the food industry

# Explosion protection

## Directives and standards

### History

Until the end of 1975, numerous national directives covering the field of explosion protection existed in the individual European states. On 18 December 1975, the first framework directive on explosion protection above ground came into effect, applying in the member states of the European Union: 76/117/EWG.

Until 1990, the directive 76/117/EWG was modified several times. The different national directives were directly related to standards that applied exclusively to electrical equipment and to explosion protection above ground. The fact that national directives were still in effect restricted free trade in this area.

In the beginning of 1994, the "Framework Directive 94/9/EC of the European Parliament and Council of 23 March 1994 on the approximation of the laws of the Member States concerning equipment and protective systems intended for use in potentially explosive atmospheres" was passed. This directive has regard to the "European Treaty" of 1985, in particular article 100a (amendment of 2 February 1992), establishing the European Community.

„ATEX 100a“ is the common shortcut for it and is derived from the French "atmosphère explosible" (explosive atmosphere). In addition to article 100a, there are further articles which are in progress of being transposed into directives. Whenever the ATEX directive is quoted in our TURCK documentation, reference is made to the new directive of explosion protection ATEX 100a.

Within the member states of the European Union the ATEX 100a was translated into national legislation, e.g. in the Federal Republic of Germany by the "Gerätesicherheitsgesetz (§11 GSGV)" – since 1 December 2011 „Produktsicherheitsgesetz (§34 ProdSG) and the "Explosionsschutzverordnung (EXVO) (11. ProdSV)".

The national directives applying for explosion protection were valid until 30.06.2003. The ATEX 100a came into force on the 01.07.2003 and has been updated and renamed to ATEX 95a. Efforts to harmonize the explosion protection directives on international level, resulted in the establishment of the IEC 60079. The pursuit towards free trade worldwide was the leading motive for it. In a first step, the IECEx framework was defined, fixing the conditions of approval for devices. Further-

more a quality management system is stipulated which is binding for the manufacturer.

### Installation and operation of electrical equipment in hazardous areas – standards and regulations

Involved with installation, acceptance and operation of electrical equipment are:

- The legislator having industrial supervision, trade organizations, TÜV and experts as supervisory authorities.
- All plant personnel are required to observe strict guidelines such as health and safety and other work regulations that govern the maintenance and operation of electrical equipment located in the hazardous area.
- Plant builders who must meet safety requirements according to EN 60079-14, (RL 1999/92/EG), ATEX 137.
- The manufacturers of components bound by constructional requirements set forth by IEC/EN 60079 resp. ATEX 95a (RL 94/9/EG).

### EN 60079-14 resp. DIN VDE 0165 – Installation of electrical equipment in explosion hazardous areas

The DIN VDE 0165 includes the safety requirements that must be observed (e. g. identification and classification of explosion hazardous locations, temperature classes, cable routing, requirements for the installation of electrical devices in zones 0, 1 and 2, many specific provisions). Contrary to the standards described above, which are primarily for manufacturers, this standard applies to plant builders, operators and test personnel.

The rules for interconnection derive from the installation regulations acc. to IEC 60079-14 or rather EN 60079-14. According to these, the safety-related maximum values of the equipment's input and output parameters must be compared in order to evaluate if several interconnected devices with intrinsically safe circuits comply with the demands on intrinsic safety.

### BetrSichV – Industrial safety regulations

The industrial safety regulations BetrSichV provides information about the safety and health protection of work equipment and their intended use. Furthermore BetrSichV regulates the operational safety of systems requiring monitoring and the organization of health and safety of workers.

### ATEX 137 – Directive for system operators

The directive 1999/92/EC of the European Parliament and Council of 16 December concerning the essential health and

# Explosion protection

safety requirements is intended to guard workers against the potential hazards of an explosive atmosphere (formerly ATEX 118, now ATEX 137). It is directed at system operators and employers and contains binding regulations. Among other things, this stipulates the assessment of risks resulting from a potentially explosive atmosphere, the keeping of areas exposed to potentially explosive atmospheres and the keeping of an explosion protection document.

## ExVO – Explosion protection directive

The ExVO regulates the placing on the market of devices, protective systems and components intended for use in potentially explosive atmospheres and is the German transposition of the directive 94/9/EC. It describes the essential health and safety requirements and mandatory conformity assessment procedures. The ExVO is thus mainly aimed at manufacturers of devices, maintenance and test personnel.

Like the directive 94/9/EC, ExVO excludes the following equipment from its scope (summarised): Medical devices, explosive substances, or unstable chemicals, personnel protection equipment, seagoing vessels, offshore systems and products for military purposes.

## EN 60079-0 – Electrical equipment for use in explosion hazardous areas, general requirements

EN 60079-0 contains general provisions for the construction and testing of any electrical apparatus to be used in explosion hazardous areas. The EN 60079 standards listed below describe different technical implementations of ignition protection classes:

- Pressure-tight encapsulation (EN 60079-1)
- Pressurized encapsulation (EN 60079-2)
- Powder-filled encapsulation (EN 60079-5)
- Oil immersion (EN 60079-6)
- Increased safety (EN 60079-7)
- Intrinsic safety (EN 60079-11)
- Ignition protection n (EN 60079-15)
- Moulded encapsulation (EN 60079-18)
- Intrinsically safe electrical systems (EN 60079-25)
- Optical radiation (EN 60079-28)

## EN 60079-11 – Increased safety (i)

All methods of protection attempt to contain an explosion on the inside of the housing and to prevent penetration of an ignitable gaseous mixture.

The method of “intrinsic safety” is based on a different approach. It limits the electrical energy to such an extent, that elevated temperatures, sparks or arcs are incapable of generating the energy needed to ignite an explosive atmosphere.

Due to the limitation of electrical energy, these circuits are especially suited to application in the field of measuring, control and instrumentation. The method of “intrinsic safety” has some significant advantages over other protection methods, e.g. maintenance and wiring of live circuits. Thanks to the use of inexpensive components, these systems are easy to handle and cost effective, and several suppliers offer components with protection class „i“.

## Definition of terms

### Explosion

An explosion is an exothermic reaction of a material (such as gas, fumes, or dust) occurring at a high reaction speed. The risk of an explosion exists wherever there is the probability of an explosive atmosphere. An explosive atmosphere may occur wherever dusts, flammable gases or liquids are handled, processed, transported or stored. Such hazardous atmospheres can be present for instance in chemical industries, gas stations, refineries, power plants, paint shops, vehicles, sewage plants, grain mills, airports, grain silos and filling plants.

### Explosion hazards

Explosion hazards only exist in locations

- in which ignitable concentrations of flammable substances can exist under normal operating conditions or in the event of faults, and when these conditions provide the probability that a dangerous substance to air mixture is enough to form an explosive mixture;
- where the explosive or ignitable mixtures can come in contact with a source of ignition and continue to burn after ignition.

### Explosive mixture (general term)

A combustible (flammable) mixture is a mixture of gases or vapours, or a mixture of gases and vapours with mists and dusts, capable of propelling a reaction after ignition.

### Explosive atmosphere

An explosive atmosphere contains gases, vapours, fumes or

dusts mixed with air as well as the usual filler materials that can explode spontaneously under atmospheric conditions (see also 'Explosive mixture'). An explosive atmosphere may occur wherever dusts, flammable gases or vapours are handled, processed, transported or stored.

#### Explosive atmosphere (hazardous)

A hazardous explosive atmosphere is a mixture containing concentrations of flammable gases or vapors that, when ignited, can cause damage to persons directly or indirectly through an explosion.

#### Hazardous area

A hazardous area is an area in which there is a risk of explosion, i.e. a hazardous explosive atmosphere can occur due to local operating conditions. Such hazardous atmospheres can be present for instance in chemical industries, gas stations, refineries, power plants, paint shops, vehicles, sewage plants, grain mills, airports, grain silos and filling plants.

#### Ignition triangle

In order to have an explosion, the following three components must be present simultaneously:

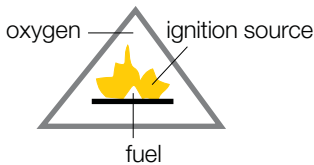

Possible sources of ignition

- hot surfaces
- flames and hot gases
- mechanically generated sparks
- electrical installations
- transient currents
- static electricity
- lightning, ultrasonic energy

oxidizers

- air (21 % oxygen)
- pure oxygen
- oxygen releasing compounds (potassium permanganate)

Flammable substances

- Flammable concentrations of gases and powders from liquids or solids with ignition capability.

#### Explosive limits

A mixture is only explosive if the concentration is within certain material specific limits. These limits are called the upper and lower explosion limits and are listed in appropriate tables.

#### Flash-point

The flash-point is the lowest temperature at which a liquid releases sufficient vapors that can be ignited when close to an energy source and extinguished when the energy source is removed.

#### Primary and secondary explosion protection measures

Basically there are two methods used to prevent an explosion.

##### Primary explosion protection

The primary method of explosion protection comprises measures which prevent formation of a dangerous atmosphere:

- avoiding the use of flammable liquids
- increasing the flashpoint
- limiting the concentration to safe levels
- natural and technical ventilation
- Monitoring of the concentration...

(see also 'Secondary explosion protection')

##### Secondary explosion protection

The secondary method of explosion protection comprises measures which prevent ignition of a dangerous atmosphere. Here, constructive or electrical techniques are used to

- segregate the electrical parts of the equipment likely to ignite a dangerous mixture, by keeping the explosive atmosphere away from the ignition source
- prevent an explosion by impeding the propagation to the surrounding explosive atmosphere

(see also 'Primary explosion protection')

## Electrical equipment featuring ignition protection class „Intrinsic Safety“ (IEC/EN 60079-11)

#### Intrinsically safe and associated electrical equipment

The term "intrinsic safety" implies that the electrical energy of an intrinsically safe circuit is limited to such an extent that a thermal effect or spark is incapable of igniting an explosive atmosphere under specified conditions.

TURCK devices for use in explosion hazardous areas comply with the ignition protection class "intrinsic safety". The devices are divided into two different kinds of electrical equipment, intrinsically safe equipment and associated equipment. The different device types are differently labelled (see „Marking of devices“). Intrinsically safe electrical equipment incorporates only intrinsically safe circuits. Direct installation in explosion hazardous areas is permitted, provided that all related requirements are met. An example is a NAMUR sensor approved according to EN 60947-5-6 or a transmitter.

Associated electrical equipment is any equipment which may incorporate both intrinsically safe and non-intrinsically safe circuits. Intrinsically safe devices may be connected to associated electrical equipment, provided that all essential conditions for this kind of interconnected assembly are fulfilled. An isolating switching amplifier would be an associated electrical device and the connected NAMUR sensor is the intrinsically safe device.

Associated electrical equipment must generally be installed outside the hazardous area. If installed within the hazardous area, additional protection measures must be provided. Many TURCK devices are approved for zone 2, allowing to install de-

vices in the Ex-area. All TURCK devices featuring intrinsically safe circuits are classified as associated equipment, such as the interfacemodul for example.

### Simple electrical equipment

Simple components and simple equipment that do not generate or store more than 1.5 V, 0.1 A and 25 mW, and do not require a test certificate are classified as “simple electrical equipment” (e.g. thermocouples). This equipment is defined in the standard EN 60079-14.

### Categories

Intrinsically safe and associated electrical equipment are divided into 3 categories according to 60079-11. This classification is determined by the failure probability and the ignition capability of the intrinsically safe circuitry.

#### Category ia:

Category „ia“ indicates that the electrical equipment should not be able to ignite a dangerous mixture during normal operation and in the event of a single fault, nor in the event of any combination of two faults. Intrinsic safety must be maintained even when two independent faults occur at the same time. Therefore, components of any equipment of category “ia” that are susceptible to faults must be present in triplicate.

#### Category ib:

An electrical apparatus, category „ib“ should not be capable of causing ignition under normal operating conditions in the event of a single fault. Intrinsic safety must be maintained in the event of a single fault. A fault could be the failure of a component that is susceptible to disturbances. Any electrical equipment classified as “ib” must have all components in duplicate

#### Category ic:

Electrical equipment classified as category “ic” should not be capable of causing ignition during normal operation. This ignition protection class replaces the ignition protection class „nL“ as from 2011 for installation in zone 2. The advantages of intrinsically safe circuits are thus also available there.

### Ignition protection class n (EN 60079-15)

Electrical equipment featuring ignition protection class n can only be installed in zone 2 or 22. It should neither cause ignition nor be serviced during normal operation. This should be guaranteed through labels and mechanical locking.

### Groups and temperature classes

Electrical equipment for use in explosion hazardous areas is classified into groups and classes based on the likelihood of an explosion danger. This is of great importance from a safety aspect as well as an economical aspect because it determines the requirements that must be met by the electrical equipment. The definition of groups is based on the location in which the equipment is going to be used.

- Group I classified equipment may be used in mines susceptible to firedamp and must conform to EN 60079 and additional mining standards (e.g. EN 50303).
- Group II classified equipment is used in all explosion hazardous areas except mining applications susceptible to firedamp.

Group II classified equipment is used in all explosion hazardous areas except mining applications susceptible to firedamp. Depending on the application, different flammable materials with different ignition energy ratings are needed. From a practical point of view, subdividing Group II is therefore necessary and makes sense, not only for economical reasons.

The subdivision of Group II equipment is based on the different ignition energy of the flammable materials. The different groups are classified by capital letters in ascending alphabetical order according to the hazard risk of the associated material. Materials belonging to group C require less ignition energy than Group A materials (see table 1)

	T1	T2	T3	T4	T5	T6
I	methane					
II A	acetone, ethane, ethyl acetate, ammonia, benzene, acetic acid, carbon monoxide, methanol, propane, toluene	ethyl alcohol, i-amyl acetate, n-butane, n-butyl alcohol,	benzines, diesel fuel, aviation fuels, fuel oils, n-hexane	acetaldehyde, ethyl aether		
II B	town gas (coal gas)	ethylene*)				
II C	hydrogen	ethylene*)				carbon disulfide*)

\*) no authorized regulations available

Tab. 1: Flammable materials – groups and temperature classes

### Temperature class

The temperature class specifies the maximum allowable surface temperature of an apparatus. In this category, the explosion protected apparatus can be approved for different temperature classes - a decision which depends on technical and economical considerations.

In the majority of cases, explosion proof equipment for the lowest temperature can be very expensive to buy and install. By comparison, using products featuring ignition protection class „intrinsic safety“ is more efficient and cheaper. Only intrinsically safe equipment for direct installation in Ex areas requires temperature classification. For associated apparatus this classification is not needed.

### Ignition temperature

The ignition temperature (defined as the temperature at which a mixture self-ignites during testing) is directly related to the temperature class. The temperature class indicates the maximum surface temperature of an apparatus and must be lower than the minimum ignition temperature of the flammable material to prevent an ignition (see table 2 on next page).

Temperature class IEC/EN NEC 505-10	Maximum surface temperature of device (°C)	Ignition temperatures of flammable materials (°C)
T1	450	>450
T2	300	>300 ≤ 450
	280	>280 ≤ 300
	260	> 260 ≤ 280
	230	> 230 ≤ 260
	215	> 215 ≤ 230
T3	200	> 200 ≤ 300
	180	> 180 ≤ 200
	165	> 165 ≤ 180
T4	160	> 160 ≤ 165
	135	> 135 ≤ 200
T5	120	> 120 ≤ 135
	100	> 100 ≤ 135
T6	85	> 85 ≤ 100

Tab. 2: Temperature classes with maximum admissible surface temperatures and ignition temperatures

### Device groups and categories acc. to the ATEX directive

The ATEX directive prescribes a clear marking of the application and the constructional level of safety. EN 60079-11 also provides detailed information on how the protection measures were realised and which applications are permitted and uses similar terms, but the information provided by EN 60079-11 and ATEX may be essentially different.

The first criterion of the ATEX directive is the device group. Like the groups described above, the different groups are defined and described according to their place of use.

- Device Group I: For mining underground with a potential hazard due to firedamp and/or combustible dusts.
- Device Group II: For all other locations in which a potentially explosive atmosphere exists.

The second criterion is the device category, defining the level of safety:

- Device category 1: Very high level of safety; devices featuring two independent means of protection; even in the event of rare device disturbances, the device remains functional and maintains the requisite level of safety.
- Device category 2: High level of safety; devices featuring one means of protection. Even in the event of frequently occurring device disturbances or equipment faults which normally have to be taken into account, the device provides the requisite level of safety.
- Device category 3: Normal safety; the device ensures the requisite level of safety during normal operation.

Devices classified as Group I (underground mining susceptible to firedamp) uses the prefix M, e. g. M1, in addition to the category classification.

The third criterion is the substance group which characterises the application of devices in particular atmospheres:

- Substance group G: Explosion protection in explosive atmospheres due to gases, vapours or mists (G: gas)
- Substance group D: Explosion protection in explosive atmospheres due to dusts (D: dust)

The equipment category also determines whether the device is an associated apparatus or an intrinsically safe apparatus. If it is an associated apparatus the device category is put into round brackets, for example II (1) G.

### Equipment protection level EPL

Devices are classified according to their potential hazard. According to IEC 60079-0 equipment protection levels are defined as follows:

#### Gas explosion protection

EPL Ga:

- Device with very high protection level
- The device is no potential source of ignition and provides the requisite level of safety when used for its intended purpose and with irregularly arising faults.

EPL Gb:

- Device with high protection level
- The device is no potential source of ignition and provides the requisite level of safety when used for its intended purpose and with irregularly arising faults.

EPL Gc:

- Device with increased protection level
- The device is no potential source of ignition and provides the requisite level of safety.
- The device features additional protection to ensure the requisite level of safety.

#### Dust explosion protection

EPL Da

- Device with very high protection level
- The device is no potential source of ignition and provides the requisite level of safety when used for its intended purpose and with irregularly arising faults.

EPL Db:

- Device with high protection level
- The device is no potential source of ignition and provides the requisite level of safety when used for its intended purpose and with irregularly arising faults.

EPL Dc:

- Device with increased protection level
- The device is no potential source of ignition and provides the requisite level of safety.
- The device features additional protection, to ensure the requisite level of safety with faults expected to occur regularly.

### EPL and zones

Devices with a higher protection rating can be use in applications with lower protection ratings. Devices approved for zone 0 can also be applied in zone 1 and devices for zone 20 in zone 21.

Device protection rating	Zone
Ga	0
Gb	1
Gc	2
Da	20
Db	21
Dc	22

# Zone classification

## Zone classification

According to EN 60079-10 and EN 1127-1, explosion hazardous areas are divided into zones such as flammables gases, vapours, mists and combustible dust. The classification is based on the likelihood that a dangerous explosive atmosphere occurs. The ATEX directive has re-defined the zone division as follows:

Classification

- Zones 0, 1 and 2 for gases, vapour and mist
- Zones 20, 21 and 22 for dusts

## Zone classification for gases

### Zone 0

Zone 0 comprises locations in which a dangerous explosive atmosphere is present continuously or frequently. The definition is extended by the term „frequently“. The example shows a gas station with zones classified as 0.

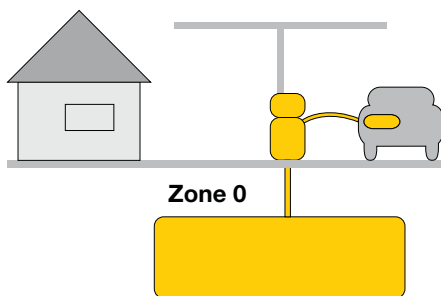

Intrinsically safe devices designed for use in zone 0 must meet category "ia" safety standards and must have no live contacts. Galvanic isolation between intrinsically safe and non-safe devices is to be preferred. If grounding of the intrinsically safe circuit is required for functionality, this must be done outside zone 0, but as close as possible to zone 0. The devices must as well be approved for gas groups IIA, IIB and IIC.

### Zone 1

Zone 1 are locations in which explosive atmospheres are likely to occur. Here ATEX does not incorporate any changes. The example shows the area near the gas pump during refuelling classified as zone 1.

Generally the following areas in industrial plants are considered to be zone 1 locations:

- in the vicinity of zone 0
- close to inspection openings
- near filling and draining devices
- inside of machinery

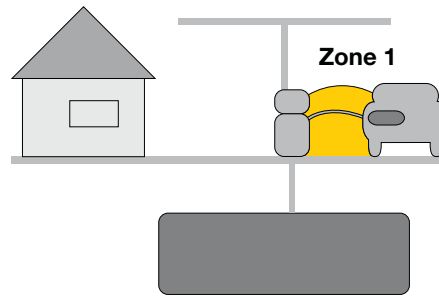

Any device certified for zone 1 must be group IIA, IIB or IIC and at least category "ib".

### Zone 2

Zone 2 are locations in which an explosive or dangerous explosive atmosphere is likely to occur only rarely and if, only for a short time. According to the ATEX definition, an explosive atmosphere should not occur, but, if it does, only infrequently and for a short period. The following industrial areas comply with it:

- Areas near zone 0 and 1
- Areas near flange seals whenever standard flange joints are used
- Areas near pipes in closed rooms

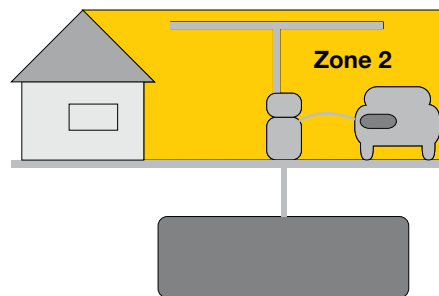

Unlike apparatus for zones 0 and 1, devices for use in zone 2 do not require a test certificate by an authorized body. Devices must conform to category 3 and must meet the following criteria (EN 60079-15):

- restricted breathing enclosures (excess temperature 10 K only)
- sealed enclosures (various test methods/requirements)
- simple pressurized enclosure (like „p“ without purging)
- limited energy (intrinsic safety without safety factor, category)
- encapsulated switching devices (simple pressurized enclosure)
- lower requirements for devices in zone 1, e.g.
  - clearances and creepage
  - housing impact test
  - plastic materials
  - construction of lamp holders and starters

**Installation of devices in zones 0 to 2**

For installation in zones 0 to 2 (gas, vapour) it is required that intrinsically safe and associated devices must meet at least those requirements applying to the zone in which the intrinsically safe apparatus is to be installed. If a device meets higher requirements, operation is obviously permitted. The national regulations apply to interconnected assembly and installation of devices. Please refer to „Guidelines for use of devices with intrinsically safe circuits“ below.

**Combustible dusts and fibers**

**Zone 20**

According to ATEX, zone 20 is classified as an area in which a dangerous explosive atmosphere in the form of a dust cloud is continuously present, or occurs frequently, or for a long period. The possibility of a dust deposit with a known or excessive thickness is given. The presence of dust deposits as a single event does not constitute a zone 20 classification. Usually, these conditions can only prevail inside an enclosure, pipes and instruments.

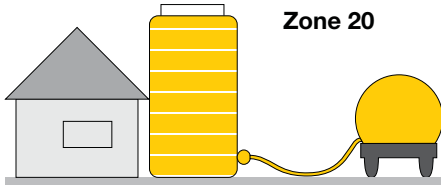

Areas, in which dust deposits occur, but where clouds of dust are not present constantly, frequently or for a long term, do not belong to this zone.

**Zones 21 and 22**

**Zone 21**

Areas in which a potentially explosive atmosphere in the form of a dust cloud can occur occasionally during normal operation. Dust deposits or layers of combustible dust will usually be present.

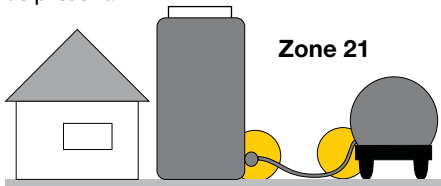

These can be areas in the close vicinity of filling or dust extraction stations, where dust deposits are present and explosive concentrations of flammable dust mixed with air may occur during normal operation.

**Zone 22**

Areas in which it is unlikely that a potentially explosive atmosphere in the form of a dust cloud occurs during normal operation. If such an atmosphere occurs, then only for a short period, or in the event of dust accumulation, or in layers of combustible dust.

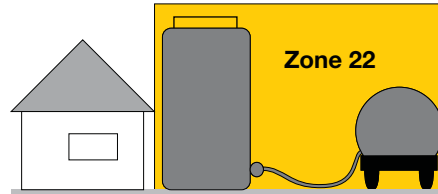

For example, areas in the vicinity of equipment containing dust which can escape through leakages and where dust deposits can build up (e.g. mills from which dust is released and accumulates).

**Installation of devices in zone 20 to 22**

Regarding areas of combustible dust, installation, operation and maintenance of devices are subject to the national regulations (EN 60079-14/EN 61241-14). Intrinsically safe devices mounted in zone 20 to 22 must have the appropriate approval. Associated equipment does not require an approval for flammable dusts, an approval for gases and vapour is sufficient. It must be ensured that the limit values of intrinsic safety of the EC type examination certificate are met in the case of an interconnected assembly. Then it is permitted to mark the intrinsically safe device as II 1 D and the associated equipment as II (1) G. To avoid mistakes, the marking II (1) G, II (1) D is usual.

During installation the special conditions of dust protection must be observed. Simple devices for use in zones 20 to 22 must have an approval, whereas this is not necessary for simple devices applied in zones 0 to 2.

Zone classification	Likelihood of an explosive atmosphere	Compliance with safety requirements by	Requirements fulfilled by:		
			Equipment group	Related equipment category	Additional equipment category
Zone 0 (gas, ...)	Continuously, for long periods or frequently	2 independent means of protection	II	1G (for gas, ...)	–
Zone 20 (dust)			III	1D (for dust)	
Zone 1	Occasionally	1 independent means of protection	II	2G	1
Zone 21			III	2D	
Zone 2	Unlikely or infrequently - for a short period only	Normal operation	II	3G	1 or 2
Zone 22			III	3D	

Tab.3: Zone classification – equipment categories



# Marking of devices

## Marking of devices

### Marking of devices conforming to CENELEC

Equipment for explosion protected areas must be clearly marked. There are two different types of marking. According to CENELEC, marking of an apparatus conforming to EN 50014/20 must provide the following information:

- manufacturer's name or trademark
- part number
- serial number
- authorized body
- Ex symbol
- ignition category, e.g. „ia“
- "x" after the test certificate number indicates that special conditions must be met (see certificate for special conditions)
- designated group together with the respective subdivision (e.g. IIC)
- temperature class or maximum surface temperature (for group II devices)
- test authority, date and file number
- device protection rating, e.g. „Ga“

An intrinsically safe device is to be marked as follows:

<b>Ex ia IIC T6 Ga</b>	
Ex	complies with European standard
ia	Ignition protection (category)
IIC	explosion category
T6	temperature class
Ga	device protection rating

Associated equipment is to be marked as follows:

<b>[Ex ia Ga] IIC</b>	
Ex	complies with European standard
ia	Ignition protection (category)
IIC	explosion category
Ga	device protection rating

### Marking of devices conforming to ATEX

The test certificate number of the EC type examination certificate acc. to the ATEX directive:

<b>PTB 97 ATEX 2128X</b>	
PTB	authorized body
97	year of examination
ATEX	acc. to directive 94/9/EG
2128	test certificate number
X	special conditions

Within the European Union the devices must meet the respective requirements. If the manufacturer fulfills these, he is permitted to affix the CE sign with the identification number of the notified body, which carried out the quality assurance system approval.



The test authority TÜV Hannover has the ID number 0044, EXAM (BVS) Bochum 0158 and PTB Braunschweig 0102.

The year of production and the constructional level of safety acc. to ATEX must be also contained in the device's marking.

For intrinsically safe devices the marking would be:

<b>II 1 G</b>	
II	all areas except mining
1	very high safety level suited for zone 0
G	explosion protected against gas, vapour and mist

Associated equipment is identifiable by round brackets enclosing the device category:

<b>II (1) G</b>	
II	all areas except mining
(1)	may not be installed in Ex areas
G	explosion protected against gas, vapour and mist

## Manufacturer obligations

**The manufacturer must provide a certificate of conformity and EC type examination certificate from an authorized test body.**

The authorized body implements tests and certifies that the devices comply with the regulations and standards of the explosion hazardous area. The manufacturer is required to supply a type test sample to an authorized test body, which draws up a test report to be submitted to the notified body entitled to issue the EC type examination certificate after verifying conformity. Notified bodies and external inspection bodies are registered centrally.

The EC type examination certificate contains all Ex-relevant data for devices of zone 0 and 1. It is the manufacturer's responsibility to keep a copy of the certificate. Along with the certificate, the manufacturer provides an instruction manual with all relevant Ex data. In addition, the manufacturer issues a declaration of conformity, stating that all applicable standards and directives are met. The user needs these documents to document compliance of the system installation.

### CE marking of equipment

Devices for use in explosion hazardous areas are provided with the CE marking and the identification code of the testing

authority. The assessment procedure for CE marking is clearly defined and depends on the device category. The example shown relates to device category 1, featuring the highest safety level. The applicable annexes of the directive 94/9/EC are also shown.

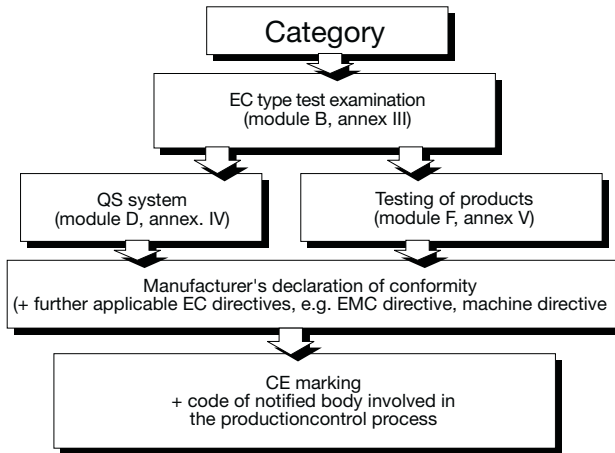

Different annexes apply to the various device categories.

**QA – Assessment of the quality assurance system**

The manufacturer of intrinsically safe devices, categories 1 and 2, must have an approved quality management system. This approval is needed to ensure that the manufacturer produces the devices according to the test type sample and that conformity to relevant protection regulations is given. Assessment of the quality assurance system is carried out by a notified body. Assessment can be achieved in two different ways:

Assessment and certification can be done directly within the scope of certification according to ISO 9000ff. Approval of those fields associated with explosion protection is accomplished in cooperation with an expert of the notified body. If the ISO certificate has already been granted, it is possible to certify those parts relating to explosion protection subsequently within the scope of an additional audit. The following illustration shows both possibilities:

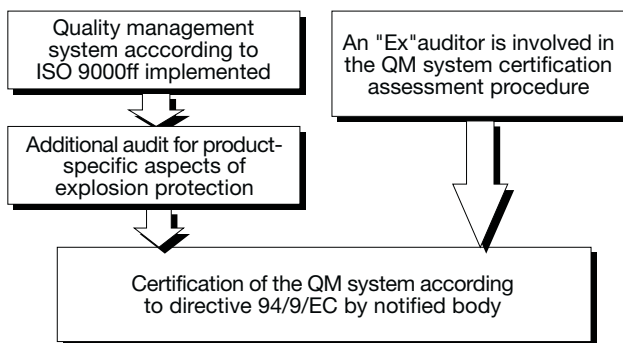

TURCK's manufacturing sites for explosion protected devices are certified according to ISO 9001 and have a quality system approval.

# Guidelines for use of devices with intrinsically safe circuits

**Guidelines for use of devices with intrinsically safe circuits**

The national regulations and standards are the basis for use of devices with intrinsically safe circuits. These must be strictly observed and followed. The user is obliged to inform himself of all revisions. The following guidelines relate to the ATEX (94/9/EC) directive of the member states of the European Union, especially to the field of explosion protection in areas exposed to hazards by gas. If the device is classified as associated equipment with intrinsically safe and non-intrinsically safe circuits, it may not be installed in explosion hazardous areas. It is only permitted to connect intrinsically safe devices located in the hazardous area to the intrinsically safe circuits of this device. The intrinsically safe connections of TURCK devices carry a blue marking.

When interconnecting devices within such an assembly it is mandatory to provide a proof of intrinsic safety (EN 60079-14: 2004, chap. 12.2.5). This is required to verify that all data related to explosion protection of the devices allow joint operation. Verification must include the internal capacitances and inductances of the cables used. Please refer to the special section „Proof of intrinsic safety“ for more information.

Intrinsically safe circuits should never be interconnected with non-safe circuits. Even if only interconnected once, it is possible that essential protective elements are damaged without the user being aware of this fact. A simple function test is not suited to verify a damage of this kind. Once intrinsically safe circuits have been connected to the non-intrinsically safe circuit, it is not permitted to use the device subsequently as intrinsically safe equipment. The governing regulations cover installation of intrinsically safe circuits, mounting to external connections, cable characteristics and cable installation. Cables and terminals with intrinsically safe circuits must be marked and separated from non-intrinsically safe circuits or feature appropriate isolation (> 1.500 VAC). The following is an excerpt from the requirements according to EN 60079-14:

- Protection against external electrical or magnetic fields (e.g. power lines)
- Prevent conductor splicing of fine wires through wire sleeves
- Minimum cross section of 0.1 mm (also single wires of a conductor): 0.1 mm
- Protection against damage (mechanical, chemical, thermic ...)
- Armouring, metal cladding, shielding of cables and lines
- Common use of single-core non-sheathed cables of intrinsically and non-safe circuits in one line is not permitted
- Separate error assessment when using multi-conductor cables and lines
- If cables have to be color-marked, use light-blue.

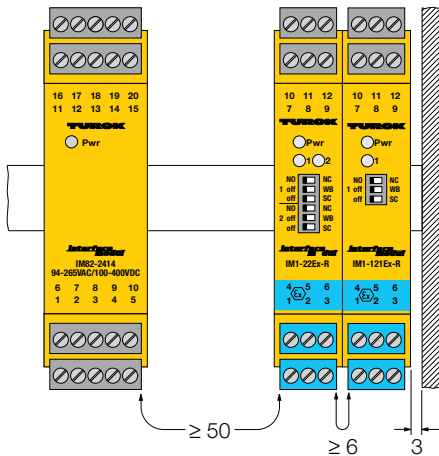

When mounting IMB devices (interface module backplane), further instructions must be observed, owing to their open construction and special connection technology:

- The devices have to be mounted such as to comply at least with protection class IP20 acc. to IEC publication 60529. Generally, this is achieved by plugging dummy modules (IMB-BM) in the free slots.
- Connections for intrinsically safe and non-intrinsically safe circuits must either be separated by a physical barrier so that they are at least 50 mm (thread measure) apart from each other, or each connection must be provided with cable sleeves which cannot slip off and ensure covering of all bare parts.

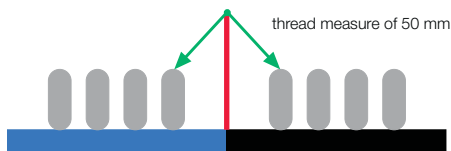

A thread measure is defined as the distance between circuits separated by a physical barrier. The reason for this regulation is that it is possible to work with live intrinsically safe circuits; thus it must be avoided that these come into contact accidentally with any non-safe connection components. This distance is only required for external connections which can be accessed by the user. The minimum distance between two intrinsically safe circuits must be 6 mm and separation from other (grounded) metal parts must be 3 mm.

- IMB devices must be coded as a protection measure against mismatching. This is done by inserting coding keys in the appropriate bores; the matching openings are located in the corresponding retainers.

The approval expires, if the device is repaired, altered or opened by a person other than the manufacturer or an expert unless the device-specific instruction manual explicitly permits such interventions. Only an expert is familiar with the in-

formation on protection measures needed to assure that the device is still in accordance with the applicable regulations after such an intervention. Visible damages to the device's housing (e. g. black or brown discoloration due to heat accumulation, perforation or deformation) indicate a serious error and the device must be turned off immediately. The associated equipment must also be checked.

Inspection of a device with regard to all relevant aspects of explosion protection may only be carried out by an expert or the manufacturer. The operation of the devices is only permitted in conjunction with the permitted data. The supply voltage for example should never exceed or fall below the indicated maximum value or the temperature range during operation.

Intrinsically safe circuits with galvanic isolation - as is the case with TURCK devices - should not be grounded, unless not absolutely necessary from a functional point of view. Circuits without galvanic isolation, like provided by Zener barriers, always require grounding. EN 60079-14 includes the relevant grounding regulations. Within zone 0 grounding of a circuit is not necessary. If grounding is necessary for functional reasons, then it must be carried out in close vicinity of zone 0.

Prior to every initial set-up or after any change of the device interconnection within the assembly, it must be ensured that all applicable regulations, directives and framework directives are met, that all safety regulations are fulfilled and that the device is functioning properly. Only then the operation is permitted.

Mounting and connection of the device should only be carried out by qualified and trained staff familiar with the relevant national and international regulations of explosion protection to ensure correct operation.

The system operator must ensure that the system is always in the required safe condition. The system must be inspected continuously and necessary maintenance work must be carried out immediately while observing the safety regulations. The system must be tested in case of need, latest every three years.

## Proof of intrinsic safety

### Proof of intrinsic safety

According to EN 60079-14 a proof of intrinsic safety must be provided to confirm that equipment interconnected within an assembly meets the requirements of intrinsic safety. In this context, a clear distinction is made between two different types of circuits:

- Simple intrinsically safe circuit with a single associated device and at least one intrinsically safe device without additional supply.
- More than one associated devices capable of supplying electrical energy to the intrinsically safe circuit, not only during normal operation but also in a fault condition.

**Simple circuit**

The first definition of a simple intrinsically safe circuit requires the observance of all electrical limit values stated in the EC type examination certificate and the power characteristics. If these conditions are met, the user is entitled to keep a proof of intrinsic safety. Inductances and capacitances of the installed cables must be taken into account.

The intrinsic safety of a simple circuit is verified, if the limit values are maintained according to the following conditions:

Associated equipment	Conditions	Intrinsically safe device + cable
$U_0$	=	$U_i$
$P_0$	=	$P_i$
$L_0$	=	$L_i + L_c$
$C_0$	=	$C_i + C_c$

This applies to circuits

- non-linear output characteristic of associated equipment and (at the same time)
- the presence of distributed reactances only.

If massed reactances are present and under the condition of linear limitation by the associated equipment, it must be checked if:

- $C_0 > 1\%$  of  $C_i$
- $L_0 > 1\%$  of  $L_i$

If one of the two conditions apply, the percentage of  $C_0$  and  $L_0$  must be reduced by half (50 % rule).

The cable characteristics provided by the manufacturer should be used. Should these not be available, the following typical values (acc. to EN 60017-14, part 12.2.2.2.) are recommended: 200 pF/m und 1 mH/m or 30 μH/Ω.

If the value  $P_0$  of the associated equipment is not specified, a linear characteristic must be available, on the basis of which  $P_0$  can be calculated:  $P_0 = \frac{1}{4} \times I_0 \times U_0$ .

The connection of proximity switches to isolating switching amplifiers, or 2-wire transmitters to isolating transducers, or solenoid valves to a valve control module can be considered

as simple circuits. The limit value indexes of the certificate of conformity and the EC type examination certificate differ. In this overview the indexes according to EN 60079-14 are used. Index „0“ stands for maximum output values and „i“ for maximum input values.

The proof of intrinsic safety should be laid down in a standardized document to facilitate clear documentation. The document should contain the date, the name of the manufacturer, the circuit type and the type code.

**Interconnection of several devices**

The second case considers interconnection of several active associated devices. Here it is not permitted to apply the electric limit values of the EC type examination certificate for the proof of intrinsic safety. This case differs fundamentally from the first one.

Different limit values apply to an assembly of individually associated devices. Such an assembly will always be classified as equipment according to category „ib“, even if the single devices comply with to category „ia“. An assembly may therefore not be installed in zone 0.

A detailed description of interconnection and assembly is beyond the scope of this introduction. The related calculation methods and an example are contained in annexes A and B of EN 60079-14. Additionally, the ignition curves of IEC 60079-11 are needed. EN 50020 also contains the ignition curves.

When interconnecting associated devices whose typical curves are not entirely linear, a special procedure must be applied. This procedure is explained precisely in EN 60079-25.

**Applicability of approvals**

**Applicability of approvals / national approvals**

Equipment certified according to the ATEX directive may be placed on the market, installed and put into service within the member states of the European Union.

Associated equipment:		Manufacturer	Test certificate no.	Expl. group	$U_0$ [V]	$I_0$ [mA]	$P_0$ [mW]	$L_0$ [μH]	$C_0$ [nF]
Designation	Type								
Isolating switching amplifier	IMB-DI-451EX-P/24VDC	TURCK	TÜV 08 ATEX 554880	[Ex ia Ga] IIC	12.0	12.4	37.2	10.0	0.49

Intrinsically safe equipment:			Manufacturer	Test certificate no.	Expl. group	$U_i$ [V]	$I_i$ [mA]	$P_i$ [mW]	$L_i$ [μH]	$C_i$ [nF]
No.	Designation	Type								
1	Proximity switch	BIM-INT-Y1X	TURCK	KEMA 01 ATEX 1264 X	EEx ia IIC T6	20.0	60.0	80.0	150.0	150.0
2	Proximity switch	BI1-EG05-Y1	TURCK	KEMA 02 ATEX 1090 X	Ex ia IIC T6	20.0	60.0	130.0	150.0	150.0

⇒	Cable inductances and capacitances: (Manufactures spec. or $L_c = 1$ mH/km. $C_c = 110$ nF/km)	Total cable length: 130 m						0.13	14.3
	Total inductances and capacitances: ( $\Sigma L_i$ and $\Sigma C_i$ )							150.13	164.3
	Intrinsic safety is achieved if all conditions are fulfilled: $U_0 \leq U_i$ $I_0 \leq I_i$ $P_0 \leq P_i$ $L_0 \geq \Sigma L_i$ $C_0 \geq \Sigma C_i$								

Example: Proof of intrinsic safety

Even though Switzerland does not belong to the EU, approvals according to ATEX are accepted. An approval by SEV is not required, if the customer provides the mandatory documentation, i.e. the instruction manual, the EC type examination certificate, the CE declaration and the certificate of the quality management audit relating to explosion protection.

Many states outside the European Union explicitly request their own national approval. Therefore TURCK devices feature approvals for many different countries. National approvals are required in countries such as the USA, Canada, China, Japan, Australia, CIS states, whereas other states accept approvals issued by other states. For this reason it is indispensable to be familiar with the national requirements.

In many states approvals are granted for a certain period only. Therefore it is recommended that check is made whether the approval has expired or has been prolonged accordingly. If an approval expires after installation, many countries accept further operation.

Approvals according to ATEX and approvals in the USA and Canada are not subject to a time limit.

## Approvals available on the internet

### Overview of approvals

---

TURCK offers their customers the opportunity to view all valid approvals and to download these at: [www.turck.com](http://www.turck.com)

# Glossary

## AIDA

AIDA ( **A**utomatisierungs **I**nitiative **D**eutscher **A**utomobilhersteller) federation of leading automotive manufacturers with the objective to standardize the production processes.

## Air interface

Is the RFID transmission zone established between data carrier and read/write head. Data is transmitted in the air interface and passive data carriers are also fed with power.

## Antenna, active

Is composed of an emitter/receiver coil and transmits radio signals between read/write head and data carrier. The active antenna is integrated in the read/write head.

## Anticollision principle

Many data carriers are read simultaneously, once they have entered the air interface of a read/write head. In order to avoid collision, the data carriers are not read exactly at the same time but rapidly, one after the other, or at different frequencies within the same frequency band.

## Operating frequency

Is the frequency band used for transmission of information between data carriers and read/write head. The RFID frequency bands are specifically defined for each technology and are also subject to certain country-specific limitations.

## BL compact

*BL compact* is a compact, IP67 rated I/O system from TURCK and is suited for confined spaces. BL stands for Bus Link.

## None

*BL ident*<sup>®</sup> stands for „Bus Link Identification“ and describes the modular design of the RFID system from TURCK.

## BL20

BL20 is a compact, IP20 rated modular I/O system from TURCK. BL stands for Bus Link.

## BL67

BL67 is a modular, IP67 rated I/O system from TURCK. BL stands for Bus Link.

## Bus System

A bus collects and transmits data and control information between different components such as CPU, memory and I/O level following a defined protocol.

## CODESYS

CODESYS (Controller Development System) is a development environment and programming system acc. to IEC 61131-3 for PLCs and programmable automation components.

## CPU

A CPU (Central Processing Unit) is the core unit of a computer, executing all important computational calculations.

## Data preservation

Is defined as ‚duration in years‘ for which data remains on a data carrier, depending on ambient temperature and other environmental influences.

## Data carrier

A data carrier is a mobile storage device consisting of a memory chip and an antenna. It can be read and written on the fly by means of RFID technology. The data carrier receives the signals and responds autonomously.

## Data carrier, active

Active data carriers have their own energy source which they use to actively send information and to supply the internal memory.

## Data carrier, passive

Passive data carriers have no own energy source. In order to send information and write to the internal memory, they receive power from the electromagnetic AC field generated by the read/write head. This is the type of data carrier mainly used in the TURCK *BL ident*<sup>®</sup> system.

## DP Master Class 1

The DP Master Class 1 (DPM1) is a central control unit in a PROFIBUS-DP system, which exchanges data in a defined message cycle with the remote stations (slaves). The DPV1 functions for acyclic transmission of demand data can optionally be used. Typical devices are PLCs or PCs.

## DP master class 2

DP master class 2 (DPM2) serves exclusively for the transmission of acyclic demand data in a PROFIBUS-DP system and is used for commissioning processes, maintenance and diagnostics of connected components. A DP master class 2 needs not be connected permanently to the bus system.

## DPV1

DPV1 is a functional expansion of the PROFIBUS-DP protocol. It enables acyclic communication of demand data in addition

to the cyclic communication of process data. The acyclic services are conducted at the same time but with lower priority than the cyclic process.

### DTM

DTM is an abbreviation for "Device Type Manager". DTMs are normally drivers for devices that are parametrized by computer, which for example can be parametrized via FDT (see also 'FDT' and 'PACTware™').

### EAN

EAN stands for „European Article Number“ and was replaced by GTIN „Global Trade Item Number“ in 2009.

### EEPROM

EEPROM (Electrically Erasable Programmable Read-Only Memory) is a non-volatile memory module that can be read, cleared and reprogrammed.

### Electronic module

The electronic modules provide the functions of the modular TURCK I/O systems in a fieldbus station independently of the fieldbus used. Plugged on the base modules, they form a functional unit with them and can be replaced at any time by other electronic modules from the same product series because they are not wired. The functions are:

- Digital inputs and outputs
- Analog inputs and outputs
- Technology modules such as RFID
- Power supply

### EMC

The electromagnetic compatibility (EMC) denotes the normally desired state in which technical devices do not cause or suffer undesired electrical or electromagnetic interference to or from other devices in the same environment.

### EPC

The Electronic Product Code (EPC) is an internationally used coding system by means of which products, product types and packaging are clearly identified through serial numbers.

### Protective ground

An electrotechnical term used to signify conductive ground whose electrical potential is always zero. The electrical potential of the ground may not equal zero in the area around grounding devices, in which case this is called the "reference ground".

### FDT

An FDT/DTM configuration tool is a modular software concept and is structured in a manufacturer-independent configuration tool as a frame application, the FDT (Field Device Tool) and manufacturer-specific device drivers, the DTMs (Device Type Manager) (see also 'DTM / PACTware™').

### Fieldbus

A fieldbus interconnects field components such as sensors and actuators with control components such as the PLC or industrial PCs. Reliable transmission of signals and real-time behaviour are common features of a fieldbus. Fieldbus systems withstand extreme loads and are mostly applied in industrial settings.

### FRAM

Also Ferro RAM, Ferroelectric Random Access Memory, is the name given to a non-volatile, electronic memory chip with read/write capability. FRAM chips are low-power consuming memories, fast writable and highly reliable in terms of data availability.

### Function block

A function block is a self-contained program that provides different status, input and output bits as well as routines. Multiple instances of a function block can be created.

### Gateway

A gateway is a hardware and software component which interconnects different networks using different protocols (protocol converter). For this, all information contained in the telegram of the 'source' protocol, except for the user data, are 'translated' into the 'target' protocol. In modular I/O systems from TURCK, the gateway is the head component of each fieldbus station interfacing the fieldbus with the field level.

### Gateway, programmable

The CODESYS programmable gateways (IEC 61131-3) can be operated as autonomous PLCs to control applications or as peripheral components in a network for local and fast signal processing where they relieve the central control of a network.

### GSD

The „General Station Description“ file, previously known as „Device master file“, describes the characteristics of the devices used. The GSD file is a readable text file and is supplied in different languages. Project planning tools require the device information in order to complete configuration and commissioning. The GSD file normally contains general information such as vendor name and version. In case of modular systems,

it also contains the communication features such as module designations, texts for diagnostic messages, parameter options and parameter names of the individual modules.

---

**HF**

HF stands for „High Frequency“ and covers the frequency band 13.56 MHz. The HF frequency band is defined by the international valid standard ISO 15693.

---

**I/O system**

Is the central point of collection and distribution of digital information or analog signals on the field level. In a point to bus wiring, field signals are collected by an I/O station, converted to a digital protocol and then send to the control via a bus cable.

---

**IEC 61131**

Stands for International Electrotechnical Commission 61131 and is an internationally valid standard for programmable logic controllers (PLC), specifying the functions, requirements and the programming language for a PLC.

---

**Initialization (memory)**

During initialization, the memory space is reserved and filled with initial values (such as variables, code, buffer, ...) required for the execution.

---

**Inlay**

The RFID microchip and the antenna are the so called „inlay“ of a Smart Label.

---

**Interface set (BL ident®)**

The *BL ident*® interface sets are fieldbus stations with a fixed scope of components. They are modularly structured and made up of one gateway and one to four RFID modules, or they are available as *BL compact* system. They provide up to 16 channels and can operated up to 8 read/write heads simultaneously. The installed gateway or rather compact station is conditioned by the fieldbus and the RFID modules used.

---

**ISO 15693**

ISO 15693 is the international radio transmission protocol. It describes the physical properties of the RFID data carriers (e.g. dimensions, load, UV and X radiation, max. temperature), the air-interface (e.g. frequency, modulation, transmit power, data rates, coding), as well as initialization, the anticollision and transmission protocol.

---

**ISO 18000-6C**

The ISO 18000-6C standard is compatible to the EPC Global Class 1 Generation 2 (also known as UHF Gen 2). It defines the physical and logical demands on transmission between a passive data carrier and a read/write head operating in the UHF frequency band.

---

**Item Level Tagging**

Describes the process of labelling goods with data carriers.

---

**Configuration (modular fieldbus stations)**

By configuration of a fieldbus station is meant the systematic arrangement of electronic modules according to their function within a station.

---

**Closed loop**

In a closed loop RFID system, the data which is stored on tags is transmitted only within the production cycle or intralogistics area.

---

**Circuit, open**

In an open loop RFID system, data carriers are attached on every product (Item Level Tagging) and leave the company after running through production and intralogistics.

---

**Read device**

see Read/write head

---

**Reading rate**

Is the maximum speed at which data is read from a data carrier. The reading rate is defined as bits or bytes per second.

---

**Read range**

The read range is the maximum possible distance at which a read/write head can read data from a data carrier. With HF technology read and write range are almost identical, whereas with UHF technology the read range is usually longer than the write range.

---

**LSB**

LSB stands for Least Significant Bit; and represents the lowest value of a digital bit string.

---

**MSB**

MSB stands for Most Significant Bit; and represents the highest value of the digital bit string.

---

**PACTware™**

PACTware™ stands for “Process Automation Configuration Tool” and is an open and manufacturer-independent operator interface for the plant-wide operation of devices, systems and communication components. PACTware™ has the FDT interface integrated. FDT (Field Device Tool) is the standard for the standardization of the interface between the device and the operator interface. The FDT enables the operation of devices between the PACTware™ frame software and the individual software modules (DTM = Device Type Manager) to be integrated simply and quickly. PACTware™ enables the devices of an installation to be configured and operated simply, quickly and efficiently, as well as diagnosed if required.



### PIB (Proxy Ident Block)

The Proxy Ident Function Block (PIB) is based on the specification of the „PROFIBUS Users Organisation“ (PNO). The PNO brings together the interests of manufacturers and users and coordinates the maintenance and further development of the PROFIBUS standard. This standard guarantees interoperability between the systems of different manufacturers. Standard communication between field devices and function block in the control system guarantees system transparency. The PIB also provides a set of data bits and commands. Interoperability brings many advantages, such as fast integration of the system in the central control and fast implementation of projects as well as protection of investments.

The modular RFID system *BL ident*<sup>®</sup> from TURCK is based on an open standard. A PIB function block for the Siemens control series S7 is available as well as a CODESYS function block which can be implemented in the programmable gateways of the modular IO systems BL20/BL67.

### Polarization (RFID)

Describes the orientation of an electromagnetic wave. There are essentially two different types, linear and circular polarization. Linear polarized waves can be aligned either vertically or horizontally, depending on the orientation of the antenna. Circular polarized fields are best suited for applications in which Smart Labels are attached to goods because it is difficult to direct the antenna properly towards the field. For this, two antennas are arranged perpendicular to each other and one antenna is triggered with a 90° phase-shifted signal. Here a distinction is made between clockwise and counter-clockwise polarization.

### Bulk reading

Acyclic reading/writing of several data carriers. The data is not read simultaneously but in rapid succession. This is done to avoid multiple reading of a data carrier and also known as anticollision principle.

### RFID

RFID stands for Radio Frequency Identification, also known as radio identification and describes the contactless identification of objects. Data is thereby read out and written to a storage medium.

### Read/Write head

A read/write head transmits data from a control unit to a data carrier and reads data from a data carrier and transmits it to the control unit. The core element of TURCK read/write heads is the active antenna.

### Read/write ranges

The attainable distances may vary due to the combination of data carrier and read/write head. The same applies to the read/write distance. It varies, depending on the data volume being read and written to the data carrier and the fly-by speed at which the data carrier passes the read/write head. The UHF read/write heads can achieve read/write ranges of several meters.

### Note

The maximally attainable read/write distance is just an ideal

value measured under laboratory conditions and may vary due to component tolerances, mounting conditions, ambient conditions and material qualities, especially when mounted in metal or upon contact with liquids. The same applies to the parameters, read/write on the fly and the maximally transferable data volume. These may also vary according to the individual application conditions in which transfer actually takes place. Depending on the data carrier used, the maximum write range can be up to 50 % shorter than the maximum read range. **Testing of the application under real operating conditions is therefore essential!** All UHF read/write heads of the *BL ident*<sup>®</sup> system are designed for single and multiple access to the data carriers.

### Write range

The write range is the maximum possible distance at which a read/write head can write data to a data carrier. With HF technology read and write range are almost identical, whereas with UHF technology the write range is usually shorter than the read range.

### Protection rating

Protection class according to IEC/EN 60529, defines the protection of the enclosure against contact with and ingress of foreign matters and moisture.

The customary protection classes of TURCK products are:

- IP20: Protection against accidental physical contact (intended for installation in cabinets only)
- IP65: Full protection against dust and hose water
- IP67: Full protection against dust and short submersion in water
- IP69K: Full protection against dust and high-pressure/steam-jet cleaning

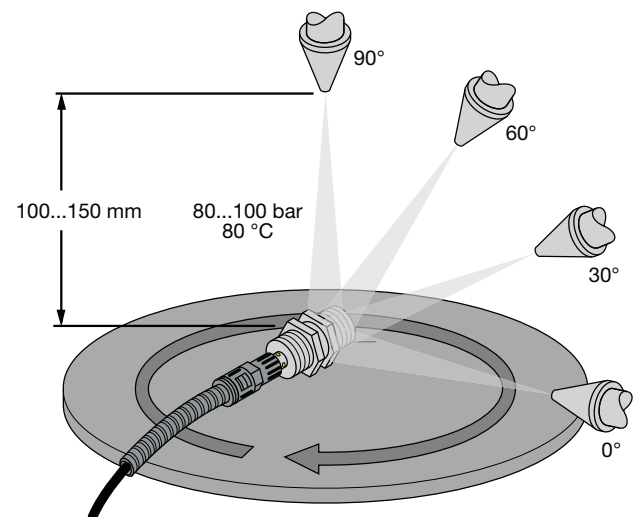

### Smart Label data carriers

Smart Labels are very flat and cost-effective data carriers on a carrier foil. They are offered as attachable and printable versions and often used as one-way data carriers.

### TAG

---

see Data carrier

### Tagging

---

When an object is equipped with a data carrier.

### Tracking & Tracing

---

Pursuing and tracing back of mobile objects in intralogistics or logistics. The procedure locates the position of goods at a certain point of time. This is meant by „Tracking“.

Whereas „Tracing“ informs about the production stages, from the raw material, over semi-fabricated products, end product up to logistics.

### Transponder

---

see Data carrier

### UHF

---

UHF stands for „Ultra High Frequency“ and covers the frequency band 865...928 MHz. The demands on the frequency band are specified in ISO 18000-6C, whereas the country-specific frequency bands are determined by the corresponding national authorities and recorded in the EPC.

Frequency bands of TURCK products:

- 865...868 MHz: Europe
- 902...928 MHz: North and South America, except Brazil
- 902...907.5 MHz and 915...928 MHz: Brazil
- 920...925 MHz: China
- 917...920.8 MHz: South Korea

### Radio Frequencies UHF

---

The TURCK *BL ident*<sup>®</sup> system operates at nationally specified transmission frequencies in the UHF range (840...960 MHz) between the data carriers and the read/write heads. UHF systems in this frequency band achieve a higher read/write range than HF systems, typically several meters. UHF transmission frequencies are country-specific, because they are allocated by national regulatory bodies. Before use, make sure that the *BL ident*<sup>®</sup> read/write heads comply with the countries' specific UHF band. Any application in regions other than the accredited ones is not permitted.

Since *BL ident*<sup>®</sup> data carriers are non-transmitting passive devices, they are worldwide applicable. In order to achieve the biggest possible air-interface, TURCK offers data carriers which are optimally tuned to country-specific frequency bands. Alternatively, also broadband data carriers are available for international use.

The different TURCK read/write heads support the following transmission frequencies:

- 865...868 MHz (Europe)
- 902...928 MHz (USA/Canada)
- 840...845 MHz and 920...925 MHz (China)
- 902...907.5 MHz and 915...928 MHz (Brazil)
- 917...920.8 MHz (Korea)

All the details concerning UHF such as frequency band, power supply and national regulations are available on:

- [http://www.gs1.org/docs/epcglobal/UHF\\_Regulations.pdf](http://www.gs1.org/docs/epcglobal/UHF_Regulations.pdf)

For more information please contact the corresponding national authorities of the country in which you want to deploy the UHF-RFID system.

### Transmission zone (RFID)

---

see Air interface



# Wiring diagrams

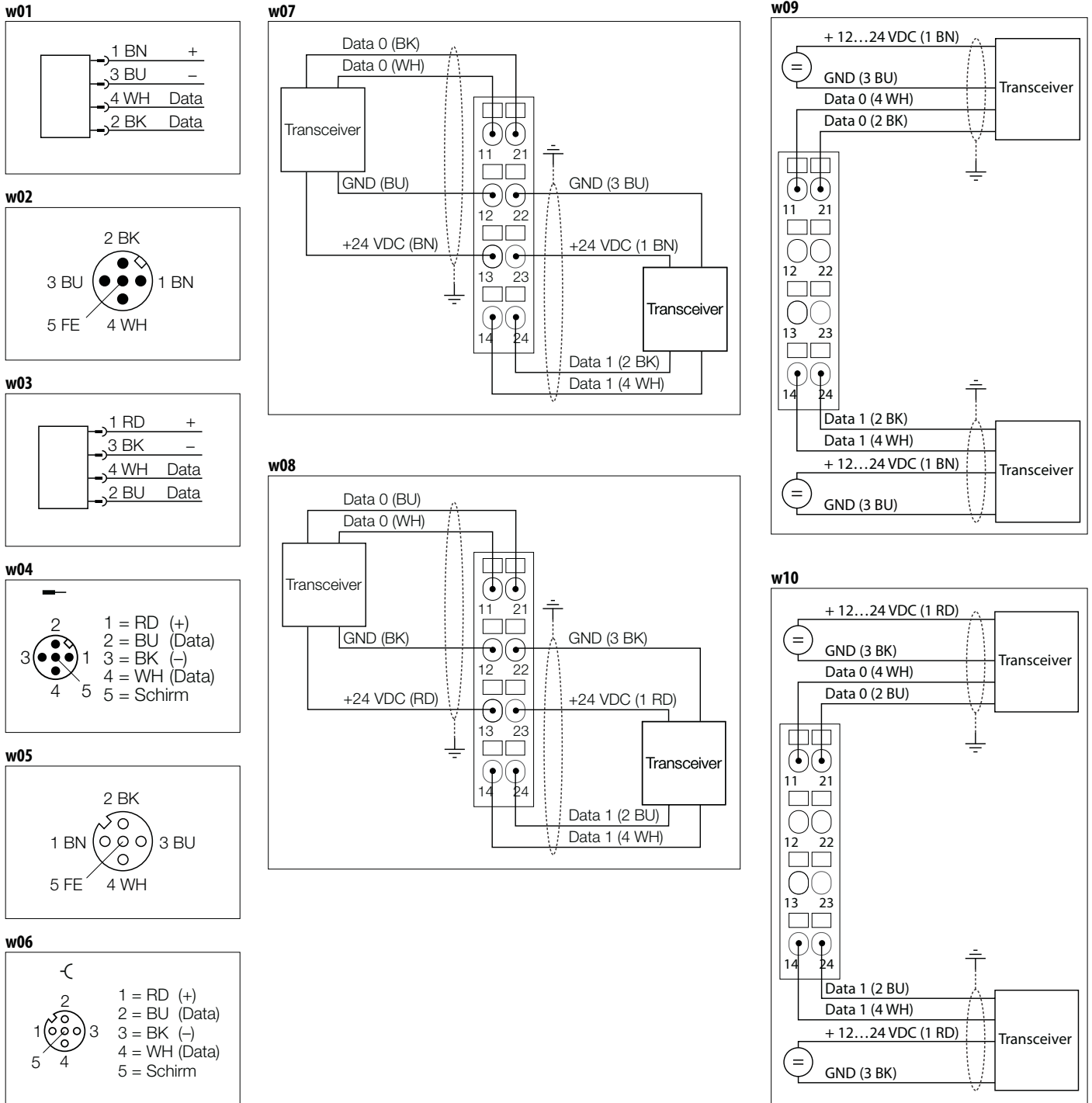

# Diagram

# Index of types

Type	Ident no.	Page	Type	Ident no.	Page
BL20-2RFID-A	6827233	39	FB-WK4.5T-5/S2500	7030285	51
BL20-2RFID-S	6827306	39	FB-WK4.5T-50/S2500	7030288	51
BL20-S4T-SBBS	6827046	39	HT-IDENT-H1147	7030236	73
BL67-2RFID-A	6827225	39	HT-IDENT-H1187	7030238	73
BL67-2RFID-S	6827305	39	KABEL-BLIDENT-100M	8036048	47
BL67-B-2M12	6827186	39	KABEL-E-BLIDENT-100M	7030351	49
BLCCO-2M12S-2RFID-S	6811300	40	MF-CK40-1S	6900481	61
BLCCO-6M12LT-2RFID-S-8XSG-P	6811303	40	MF-CK40-2S	6900482	60
BLCDN-2M12S-2RFID-S	6811002	40	MF-CK40-3S	6900483	60
BLCDN-4M12L-2RFID-S-2RFID-S	6811055	40	MF-R30	6901150	62
BLCDN-6M12LT-2RFID-S-8XSG-PD	6811049	40	MF-R50	6901151	62
BLCDP-2M12MT-2RFID-A	6811166	40	MF-R80	6901152	62
BLCDP-2M12MT-2RFID-S	6811177	40	MH-Q14	6950011	60
BLCDP-6M12LT-2RFID-A-8DI-PD	6811173	40	MW-18	6945004	55
BLCDP-6M12LT-2RFID-A-8XSG-PD	6811174	40	MW-30	6945005	57
BLCDP-6M12LT-2RFID-S-8DI-PD	6811178	40	MW-Q14/Q20	6945006	59
BLCDP-6M12LT-2RFID-S-8XSG-PD	6811179	40	PDA-IDENT	1542344	63
BS 18	69471	54	PDA-IDENT-IA	1542345	63
BSN 18	69472	54	PD-IDENT	1542331	63
BSS-18	6901320	55	PD-IDENT-HF-RBSUP	7030461	64
BSS-30	6901319	57	PD-IDENT-HF-RBTW	7030499	65
BSS-CP40	6901318	60	PD-IDENT-HF-RBUP-SMART	7030525	64
BSS-SPV2	6901316	58	PD-IDENT-UHF-RBTW-868	7030421	65
BSS-SPV4	6901347	59	PD-IDENT-UHF-RBTW-915-920	7030514	65
BSS-TSM (2 pcs.)	6901323	58	PD-IDENT-UHF-RUP-868	7030422	64
BST-18B	6947214	54	PD-IDENT-WLAN	1542340	63
BST-18N	6947215	54	PN-M18	6905310	55
BST-30B	6947216	56	PN-M30	6905308	57
BST-30N	6947217	56	QM-18	6945102	55
BST-BS	6947220	58	QM-30	6945103	56
BST-UH	6947219	58	RH-Q240L280/Q280L640	7030296	62
BST-UV	6947218	59	RK4.5T-0,3-RS4.5T/S2500	6699210	47
DS-R30	6900512	61	RK4.5T-10/S2500	6699207	47
DS-R50	6900386	61	RK4.5T-10/S2503	7030343	49
FB-RK4.5T-10/S2500	7030282	51	RK4.5T-10-RS4.5T/S2500	6699202	47
FB-RK4.5T-25/S2500	7030283	51	RK4.5T-10-RS4.5T/S2503	7030333	49
FB-RK4.5T-5/S2500	7030281	51	RK4.5T-2/S2500	8035244	47
FB-RK4.5T-50/S2500	7030284	51	RK4.5T-2/S2503	7030341	49
FB-WK4.5T-10/S2500	7030286	51	RK4.5T-25/S2500	6638421	47
FB-WK4.5T-25/S2500	7030287	51	RK4.5T-25/S2503	7030344	49

Type	Ident no.	Page	Type	Ident no.	Page
RK4.5T-25-RS4.5T/S2500	6699211	47	TI-BL20-E-DN-S-6	1545132	36
RK4.5T-25-RS4.5T/S2503	7030334	49	TI-BL20-E-DN-S-8	1545133	36
RK4.5T-2-RS4.5T/S2500	6699200	47	TI-BL20-E-DPV1-2	1545122	34
RK4.5T-2-RS4.5T/S2503	7030331	49	TI-BL20-E-DPV1-4	1545123	34
RK4.5T-5/S2500	6699206	47	TI-BL20-E-DPV1-6	1545124	34
RK4.5T-5/S2503	7030342	49	TI-BL20-E-DPV1-8	1545125	34
RK4.5T-50/S2500	6699422	47	TI-BL20-E-DPV1-S-2	1545126	34
RK4.5T-50/S2503	7030345	49	TI-BL20-E-DPV1-S-4	1545127	34
RK4.5T-50-RS4.5T/S2500	8035246	47	TI-BL20-E-DPV1-S-6	1545128	34
RK4.5T-50-RS4.5T/S2503	7030335	49	TI-BL20-E-DPV1-S-8	1545129	34
RK4.5T-5-RS4.5T/S2500	6699201	47	TI-BL20-E-EC-S-2	7030479	38
RK4.5T-5-RS4.5T/S2503	7030332	49	TI-BL20-E-EC-S-4	7030480	38
SG40/2 (ULTEM)	69497	61	TI-BL20-E-EC-S-6	7030481	38
SKN/M18	69663	56	TI-BL20-E-EC-S-8	7030482	38
SKN/M30	69664	57	TI-BL20-EIP-S-2	1545082	37
TB-EM18WD-H1147	7030224	71	TI-BL20-EIP-S-4	1545083	37
TB-EM18WD-H1147-EX	7030381	71	TI-BL20-EIP-S-6	1545084	37
TB-EM30WD-H1147	7030221	71	TI-BL20-EIP-S-8	1545085	37
TB-EM30WD-H1147-EX	7030385	71	TI-BL20-EN-S-2	1545138	37
TB-M18-H1147	7030001	71	TI-BL20-EN-S-4	1545139	37
TB-M30-H1147	7030003	71	TI-BL20-EN-S-6	1545140	37
TH-Q14L60	7030377	59	TI-BL20-EN-S-8	1545141	37
TI-BL20-DN-S-2	1545078	35	TI-BL20-E-PN-2	7030467	38
TI-BL20-DN-S-4	1545079	35	TI-BL20-E-PN-4	7030468	38
TI-BL20-DN-S-6	1545080	35	TI-BL20-E-PN-6	7030469	38
TI-BL20-DN-S-8	1545081	35	TI-BL20-E-PN-8	7030470	38
TI-BL20-DPV1-2	1545004	33	TI-BL20-E-PN-S-2	7030471	38
TI-BL20-DPV1-4	1545005	33	TI-BL20-E-PN-S-4	7030472	38
TI-BL20-DPV1-6	1545006	33	TI-BL20-E-PN-S-6	7030473	38
TI-BL20-DPV1-8	1545007	33	TI-BL20-E-PN-S-8	7030474	38
TI-BL20-DPV1-S-2	1545074	33	TI-BL20-PG-EIP-2	1545057	37
TI-BL20-DPV1-S-4	1545075	33	TI-BL20-PG-EIP-4	1545058	37
TI-BL20-DPV1-S-6	1545076	33	TI-BL20-PG-EIP-6	1545059	37
TI-BL20-DPV1-S-8	1545077	33	TI-BL20-PG-EIP-8	1545060	37
TI-BL20-E-CO-S-2	1545134	34	TI-BL20-PG-EIP-S-2	1545090	37
TI-BL20-E-CO-S-4	1545135	34	TI-BL20-PG-EIP-S-4	1545091	37
TI-BL20-E-CO-S-6	1545136	34	TI-BL20-PG-EIP-S-6	1545092	37
TI-BL20-E-CO-S-8	1545137	34	TI-BL20-PG-EIP-S-8	1545093	37
TI-BL20-E-DN-S-2	1545130	36	TI-BL20-PG-EN-2	1545053	37
TI-BL20-E-DN-S-4	1545131	36	TI-BL20-PG-EN-4	1545054	37

## Index of types

Type	Ident no.	Page	Type	Ident no.	Page
TI-BL20-PG-EN-6	1545055	37	TI-BL67-PN-AC-S-2	1545168	32
TI-BL20-PG-EN-8	1545056	37	TI-BL67-PN-AC-S-4	1545169	32
TI-BL20-PG-EN-S-2	1545086	37	TI-BL67-PN-AC-S-6	1545170	32
TI-BL20-PG-EN-S-4	1545087	37	TI-BL67-PN-AC-S-8	1545171	32
TI-BL20-PG-EN-S-6	1545088	37	TN840/920-Q120L130-H1147	7030536	95
TI-BL20-PG-EN-S-8	1545089	37	TN840/920-Q175L200-H1147	7030466	95
TI-BL67-DN-S-2	1545114	30	TN840/920-Q240L280-H1147	7030360	95
TI-BL67-DN-S-4	1545115	30	TN865-Q120L130-H1147	7030520	95
TI-BL67-DN-S-6	1545116	30	TN865-Q175L200-H1147	7030452	95
TI-BL67-DN-S-8	1545117	30	TN865-Q240L280-H1147	7030295	95
TI-BL67-DPV1-2	1545028	28	TN902/915-Q240L280-H1147	7030465	95
TI-BL67-DPV1-4	1545029	28	TN902-Q120L130-H1147	7030535	95
TI-BL67-DPV1-6	1545030	28	TN902-Q175L200-H1147	7030457	95
TI-BL67-DPV1-8	1545031	28	TN902-Q240L280-H1147	7030304	95
TI-BL67-DPV1-S-2	1545106	28	TN917-Q120L130-H1147	7030537	95
TI-BL67-DPV1-S-4	1545107	28	TN917-Q175L200-H1147	7030513	95
TI-BL67-DPV1-S-6	1545108	28	TN-CK40-H1147	7030006	73
TI-BL67-DPV1-S-8	1545109	28	TN-EM18WD-H1147	7030223	71
TI-BL67-EN-PN-2	1545040	31	TN-EM18WD-H1147-EX	7030382	71
TI-BL67-EN-PN-4	1545041	31	TN-EM30WD-H1147	7030222	71
TI-BL67-EN-PN-6	1545042	31	TN-EM30WD-H1147-EX	7030386	71
TI-BL67-EN-PN-8	1545043	31	TNLR-Q80-H1147	7030230	75
TI-BL67-EN-S-2	1545150	31	TNLR-Q80-H1147-EX	7030303	75
TI-BL67-EN-S-4	1545151	31	TNLR-Q80L400-H1147	7030204	75
TI-BL67-EN-S-6	1545152	31	TNLR-Q80L400-H1147L	7030234	75
TI-BL67-EN-S-8	1545153	31	TN-M18-H1147	7030002	71
TI-BL67-PG-DP-2	1545061	29	TN-M30-H1147	7030004	71
TI-BL67-PG-DP-4	1545062	29	TN-Q14-0.15-RS4.47T	7030235	73
TI-BL67-PG-DP-6	1545063	29	TN-Q80-H1147	7030007	75
TI-BL67-PG-DP-8	1545064	29	TN-Q80-H1147-EX	7030302	75
TI-BL67-PG-DP-S-2	1545094	29	TN-S32XL-H1147	7030008	75
TI-BL67-PG-DP-S-4	1545095	29	TNSLR-Q350-H1147	7030454	77
TI-BL67-PG-DP-S-6	1545096	29	TNSLR-Q42TWD-H1147	7030424	75
TI-BL67-PG-DP-S-8	1545097	29	TW860-960-L97-15-F-B44	7030524	101
TI-BL67-PG-EIP-2	1545069	31	TW860-960-Q25L77-B-B112	7030458	99
TI-BL67-PG-EIP-4	1545070	31	TW860-960-Q27L97-M-B112	7030464	99
TI-BL67-PG-EIP-6	1545071	31	TW865-868-L80-20-T-B44	7030484	101
TI-BL67-PG-EIP-8	1545072	31	TW865-868-Q14L60-M-B110	7030376	97
TI-BL67-PG-EIP-S-2	1545102	31	TW865-868-Q22L36-M-HT-B112	7030450	97
TI-BL67-PG-EIP-S-4	1545103	31	TW865-868-Q27-M-B112	7030374	97
TI-BL67-PG-EIP-S-6	1545104	31	TW865-868-Q51-HT-B110	7030447	99
TI-BL67-PG-EIP-S-8	1545105	31	TW865-868-R50-B110	7030257	99
TI-BL67-PG-EN-2	1545065	31	TW865-928-L76-18-21-F-M-B110	7030380	101
TI-BL67-PG-EN-4	1545066	31	TW865-928-Q20L58-B110	7030375	97
TI-BL67-PG-EN-6	1545067	31	TW902-928-Q14L60-M-B110	7030408	97
TI-BL67-PG-EN-8	1545068	31	TW902-928-Q27-M-B112	7030406	97
TI-BL67-PG-EN-S-2	1545098	31	TW902-928-R50-B110	7030404	99
TI-BL67-PG-EN-S-4	1545099	31	TW-BD10X1.5-19-B128	6901384	85
TI-BL67-PG-EN-S-6	1545100	31	TW-BD10X1.5-19-K2	6901381	85
TI-BL67-PG-EN-S-8	1545101	31	TW-BS10X1.5-19-B128	6901383	85



Type	Ident no.	Page
TW-B510X1.5-19-K2	6901380	85
TW-BV10X1.5-19-B128	6901385	85
TW-BV10X1.5-19-K2	6901382	85
TW-L49-46-F-B128	7030390	83
TW-L80-50-P-B128	7030389	83
TW-L86-54-C-B128	6900479	85
TW-Q51-HT-B128	7030364	85
TW-R16-B128	6900501	79
TW-R16-K2	7030410	79
TW-R20-B128	6900502	79
TW-R20-B128-EX	7030242	79
TW-R20-K2	6900505	79
TW-R20-K2-EX	7030245	79
TW-R30-B128	6900503	81
TW-R30-B128-EX	7030243	81
TW-R30-K2	6900506	81
TW-R30-K2-EX	7030246	81
TW-R30-M-B128	7030210	81
TW-R30-M-K2	7030206	81
TW-R4-22-B128	7030237	83
TW-R50-B128	6900504	81
TW-R50-B128-EX	7030244	81
TW-R50-K2	6900507	81
TW-R50-K2-EX	7030247	81
TW-R50-K8	7030233	81
TW-R50-M-B128	7030209	81
TW-R50-M-K2	7030229	81
TW-R7.5-B128	7030231	79
TW-R80-M-B128	7030207	83
TW-R80-M-K2	7030205	83
TW-R9.5-B128	7030252	79
WK4.5T-10/S2500	6699209	47
WK4.5T-10/S2503	7030348	49
WK4.5T-10-RS4.5T/S2500	6699205	47
WK4.5T-10-RS4.5T/S2503	7030338	49
WK4.5T-2/S2500	8035245	47
WK4.5T-2/S2503	7030346	49
WK4.5T-25/S2500	6699423	47
WK4.5T-25/S2503	7030349	49
WK4.5T-25-RS4.5T/S2500	6638425	47
WK4.5T-25-RS4.5T/S2503	7030339	49
WK4.5T-2-RS4.5T/S2500	6699203	47
WK4.5T-2-RS4.5T/S2503	7030336	49
WK4.5T-5/S2500	6699208	47
WK4.5T-5/S2503	7030347	49
WK4.5T-50/S2500	6699424	47
WK4.5T-50/S2503	7030350	49
WK4.5T-50-RS4.5T/S2500	6638426	47
WK4.5T-50-RS4.5T/S2503	7030340	49
WK4.5T-5-RS4.5T/S2500	6699204	47

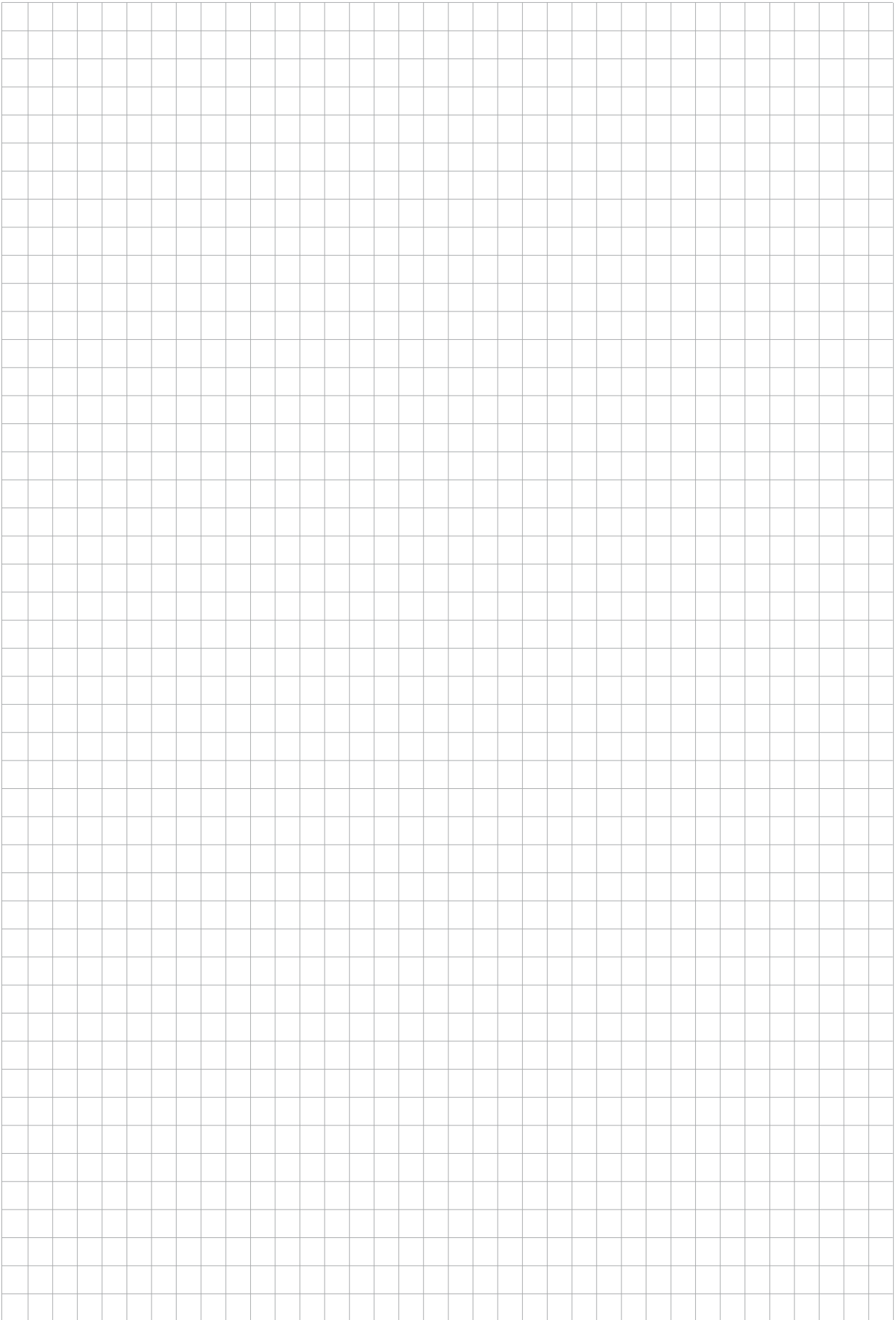



### TURCK WORLD-WIDE HEADQUARTERS

#### GERMANY

##### Hans TURCK GmbH & Co. KG

Witzlebenstr. 7  
45472 Muelheim an der Ruhr  
Germany  
P. O. Box 45466 Muelheim an der Ruhr  
Phone +49 208 4952-0  
Fax +49 208 4952-264  
more@turck.com  
www.turck.com

#### AUSTRALIA

##### TURCK Australia Pty. Ltd.

Victoria  
Phone +61 3 95609066  
australia@turck.com  
www.turck.com.au

#### AUSTRIA

##### TURCK GmbH

Vienna  
Phone +43 1 48615870  
austria@turck.com  
www.turck.at

#### BAHRAIN

##### TURCK Middle East S.P.C.

Manama  
Phone +973 13 638288  
middleeast@turck.com  
www.turck.de/en

#### BELGIUM

##### MULTIPROX N. V.

Aalst  
Phone +32 53 766566  
mail@multiprox.be  
www.multiprox.be

#### BRAZIL

##### Turck do Brazil Ltda.

São Paulo  
Phone +55 11 26712464  
brazil@turck.com  
www.turck.com.br

#### CHINA

##### TURCK (Tianjin) Sensor Co. Ltd.

Tianjin  
Phone +86 22 83988188  
china@turck.com  
www.turck.com.cn

#### CZECH REPUBLIC

##### TURCK s.r.o.

Hradec Králové  
Phone +420 495 518766  
czechrepublic@turck.com  
www.turck.cz

#### FRANCE

##### TURCK BANNER S.A.S

Marne-La-Vallee  
Phone +33 1 60436070  
info@turckbanner.fr  
www.turckbanner.fr

#### GREAT BRITAIN

##### TURCK BANNER Ltd.

Wickford  
Phone +44 1268 578888  
info@turckbanner.co.uk  
www.turckbanner.co.uk

#### HUNGARY

##### TURCK Hungary kft.

Budapest  
Phone +36 1 4770740  
hungary@turck.com  
www.turck.hu

#### INDIA

##### TURCK India Automation Pvt Ltd.

Pune  
Phone +91 20 25630039  
india@turck.com  
www.turck.co.in

#### ITALY

##### TURCK BANNER S. R. L.

Bareggio  
Phone +39 290364291  
info@turckbanner.it  
www.turckbanner.it

#### JAPAN

##### TURCK Japan Corporation

Tokyo  
Phone +81 3 57722820  
japan@turck.com  
www.turck.jp

#### KOREA (SOUTH)

##### TURCK Korea Co. Ltd.

Seoul  
Phone +82 31 500 4555  
korea@turck.com  
www.sensor.co.kr

#### MEXICO

##### TURCK Mexico S. DE R.L. DE C.V.

Saltillo  
Phone +52 844 4116650  
mexico@turck.com  
www.turck.com.mx

#### THE NETHERLANDS

##### TURCK B. V.

Zwolle  
Phone +31 38 4227750  
netherlands@turck.com  
www.turck.nl

#### POLAND

##### TURCK sp.z o.o

Opole  
Phone +48 77 4434800  
poland@turck.com  
www.turck.pl

#### ROMANIA

##### TURCK Automation Romania SRL

Bucharest  
Phone +40 21 2300279  
romania@turck.com  
www.turck.ro

#### RUSSIA

##### TURCK Rus O.O.O.

Moscow  
Phone +7 495 2342661  
russia@turck.com  
www.turck.ru

#### SINGAPORE

##### TURCK Singapore Pte. Ltd.

Singapore  
Phone +65 65628716  
singapore@turck.com  
www.turck.com.sg

#### SWEDEN

##### TURCK Consulting Office

Västra Frölunda  
Phone +46 10 4471600  
sweden@turck.com  
www.turck.se

#### TURKEY

##### TURCK Otomasyon Tic. Ltd. Şti.

Istanbul  
Phone +90 216 5722177  
turkey@turck.com  
www.turck.com.tr

#### USA

##### TURCK Inc.

Minneapolis  
Phone +1 763 5537300  
usa@turck.com  
www.turck.us



To get all product information, just scan the QR code with a smart-phone or webcam

Hans Turck GmbH & Co. KG  
Witzlebenstr. 7  
45472 Muelheim an der Ruhr  
Germany  
Tel. +49 208 4952-0  
Fax +49 208 4952-264  
E-Mail more@turck.com  
Internet www.turck.com

D500002 2013/04



Subject to change without notice

... and more than 60 representatives and agencies world-wide.